

SERVICE MANUAL

W550EU

notebook



Notebook Computer

W550EU

Service Manual

Notice

The company reserves the right to revise this publication or to change its contents without notice. Information contained herein is for reference only and does not constitute a commitment on the part of the manufacturer or any subsequent vendor. They assume no responsibility or liability for any errors or inaccuracies that may appear in this publication nor are they in anyway responsible for any loss or damage resulting from the use (or misuse) of this publication.

This publication and any accompanying software may not, in whole or in part, be reproduced, translated, transmitted or reduced to any machine readable form without prior consent from the vendor, manufacturer or creators of this publication, except for copies kept by the user for backup purposes.

Brand and product names mentioned in this publication may or may not be copyrights and/or registered trademarks of their respective companies. They are mentioned for identification purposes only and are not intended as an endorsement of that product or its manufacturer.

Version 1.0
August 2012

Trademarks

Intel, Pentium and Intel Core are trademarks of Intel Corporation.

Windows[®] is a registered trademark of Microsoft Corporation.

Other brand and product names are trademarks and /or registered trademarks of their respective companies.

About this Manual

This manual is intended for service personnel who have completed sufficient training to undertake the maintenance and inspection of personal computers.

It is organized to allow you to look up basic information for servicing and/or upgrading components of the *W550EU* series notebook PC.

The following information is included:

Chapter 1, Introduction, provides general information about the location of system elements and their specifications.

Chapter 2, Disassembly, provides step-by-step instructions for disassembling parts and subsystems and how to upgrade elements of the system.

Appendix A, Part Lists

Appendix B, Schematic Diagrams

Appendix C, Updating the FLASH ROM BIOS

IMPORTANT SAFETY INSTRUCTIONS

Follow basic safety precautions, including those listed below, to reduce the risk of fire, electric shock and injury to persons when using any electrical equipment:

1. Do not use this product near water, for example near a bath tub, wash bowl, kitchen sink or laundry tub, in a wet basement or near a swimming pool.
2. Avoid using a telephone (other than a cordless type) during an electrical storm. There may be a remote risk of electrical shock from lightning.
3. Do not use the telephone to report a gas leak in the vicinity of the leak.
4. Use only the power cord and batteries indicated in this manual. Do not dispose of batteries in a fire. They may explode. Check with local codes for possible special disposal instructions.
5. This product is intended to be supplied by a Listed Power Unit with an AC Input of 100 - 240V, 50 - 60Hz, DC Output of 19V, 3.42A or 18.5V, 3.5A (**65 Watts**) minimum AC/DC Adapter.

CAUTION

This Computer's Optical Device is a Laser Class 1 Product

FCC Statement

This device complies with Part 15 of the FCC Rules. Operation is subject to the following two conditions:

This device may not cause harmful interference.

This device must accept any interference received, including interference that may cause undesired operation.

Instructions for Care and Operation

The notebook computer is quite rugged, but it can be damaged. To prevent this, follow these suggestions:

1. **Don't drop it, or expose it to shock.** If the computer falls, the case and the components could be damaged.



2. **Keep it dry, and don't overheat it.** Keep the computer and power supply away from any kind of heating element. This is an electrical appliance. If water or any other liquid gets into it, the computer could be badly damaged.

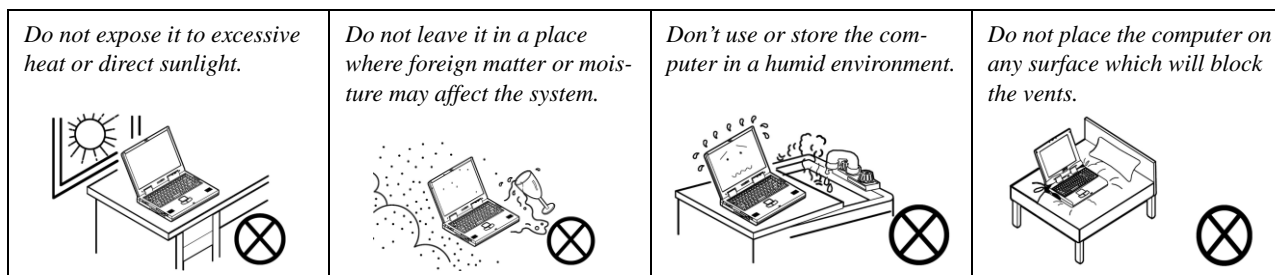

3. **Follow the proper working procedures for the computer.** Shut the computer down properly and don't forget to save your work. Remember to periodically save your data as data may be lost if the battery is depleted.

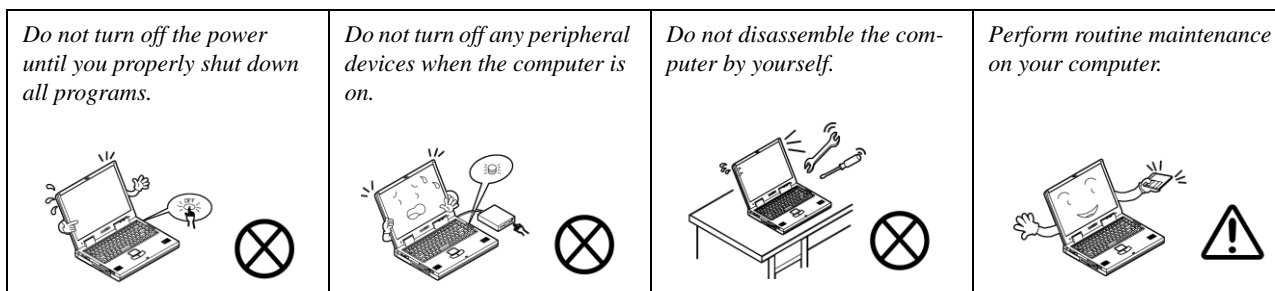

4. **Avoid interference.** Keep the computer away from high capacity transformers, electric motors, and other strong magnetic fields. These can hinder proper performance and damage your data.
5. **Take care when using peripheral devices.**

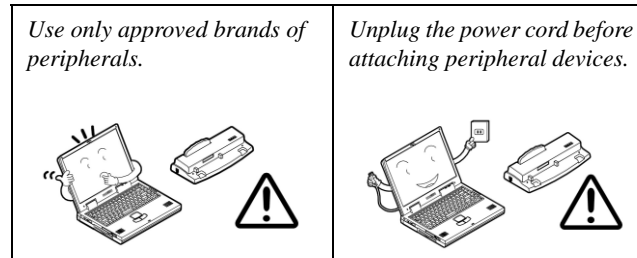

Power Safety

The computer has specific power requirements:

- Only use a power adapter approved for use with this computer.
- Your AC adapter may be designed for international travel but it still requires a steady, uninterrupted power supply. If you are unsure of your local power specifications, consult your service representative or local power company.
- The power adapter may have either a 2-prong or a 3-prong grounded plug. The third prong is an important safety feature; do not defeat its purpose. If you do not have access to a compatible outlet, have a qualified electrician install one.
- When you want to unplug the power cord, be sure to disconnect it by the plug head, not by its wire.
- Make sure the socket and any extension cord(s) you use can support the total current load of all the connected devices.
- Before cleaning the computer, make sure it is disconnected from any external power supplies.

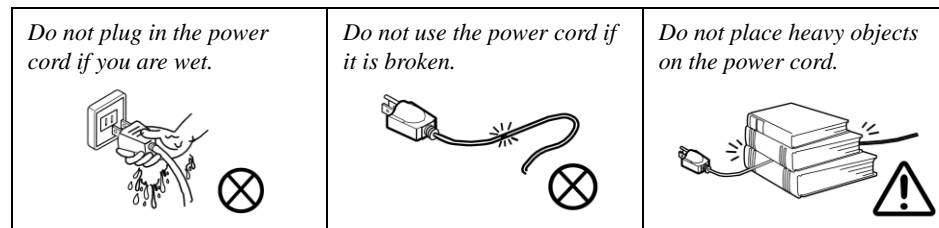

Power Safety Warning

Before you undertake any upgrade procedures, make sure that you have turned off the power, and disconnected all peripherals and cables (including telephone lines and power cord). It is advisable to also remove your battery in order to prevent accidentally turning the machine on.

Battery Precautions

- Only use batteries designed for this computer. The wrong battery type may explode, leak or damage the computer.
- Do not continue to use a battery that has been dropped, or that appears damaged (e.g. bent or twisted) in any way. Even if the computer continues to work with a damaged battery in place, it may cause circuit damage, which may possibly result in fire.
- Recharge the batteries using the notebook's system. Incorrect recharging may make the battery explode.
- Do not try to repair a battery pack. Refer any battery pack repair or replacement to your service representative or qualified service personnel.
- Keep children away from, and promptly dispose of a damaged battery. Always dispose of batteries carefully. Batteries may explode or leak if exposed to fire, or improperly handled or discarded.
- Keep the battery away from metal appliances.
- Affix tape to the battery contacts before disposing of the battery.
- Do not touch the battery contacts with your hands or metal objects.

Battery Guidelines

The following can also apply to any backup batteries you may have.

- If you do not use the battery for an extended period, then remove the battery from the computer for storage.
- Before removing the battery for storage charge it to 60% - 70%.
- Check stored batteries at least every 3 months and charge them to 60% - 70%.



Battery Disposal

The product that you have purchased contains a rechargeable battery. The battery is recyclable. At the end of its useful life, under various state and local laws, it may be illegal to dispose of this battery into the municipal waste stream. Check with your local solid waste officials for details in your area for recycling options or proper disposal.

Caution

Danger of explosion if battery is incorrectly replaced. Replace only with the same or equivalent type recommended by the manufacturer. Discard used battery according to the manufacturer's instructions.

Battery Level

Click the battery icon  in the taskbar to see the current battery level and charge status. A battery that drops below a level of 10% will not allow the computer to boot up. Make sure that any battery that drops below 10% is recharged within one week.

Related Documents

You may also need to consult the following manual for additional information:

User's Manual on CD/DVD

This describes the notebook PC's features and the procedures for operating the computer and its ROM-based setup program. It also describes the installation and operation of the utility programs provided with the notebook PC.

System Startup

1. Remove all packing materials.
2. Place the computer on a stable surface.
3. Insert the battery and make sure it is locked in position.
4. Securely attach any peripherals you want to use with the computer (e.g. keyboard and mouse) to their ports.
5. Attach the AC/DC adapter to the DC-In jack at the rear of the computer, then plug the AC power cord into an outlet, and connect the AC power cord to the AC/DC adapter.
6. Use one hand to raise the lid/LCD to a comfortable viewing angle (do not exceed 130 degrees); use the other hand (as illustrated in Figure 1) to support the base of the computer (**Note: Never** lift the computer by the lid/LCD).
7. Press the power button to turn the computer "on".



Figure 1
**Opening the Lid/LCD/
Computer with AC/DC
Adapter Plugged-In**



Shut Down

Note that you should always shut your computer down by choosing **Shut Down** from the **Start** Menu.

This will help prevent hard disk or system problems.

Contents

Introduction1-1

Overview	1-1
Specifications	1-2
External Locator - Top View with LCD Panel Open	1-4
External Locator - Front & Right Side Views	1-5
External Locator - Left Side & Rear View	1-6
External Locator - Bottom View	1-7
Mainboard Overview - Top (Key Parts)	1-8
Mainboard Overview - Bottom (Key Parts)	1-9
Mainboard Overview - Top (Connectors)	1-10
Mainboard Overview - Bottom (Connectors)	1-11

Disassembly2-1

Overview	2-1
Maintenance Tools	2-2
Connections	2-2
Maintenance Precautions	2-3
Disassembly Steps	2-4
Removing the Battery	2-5
Removing the Hard Disk Drive	2-6
Removing the Optical (CD/DVD) Device	2-8
Removing the System Memory (RAM)	2-10
Removing and Installing a Processor	2-12
Removing the Wireless LAN Module and Keyboard	2-15
Removing the 3.75G Module	2-18
Removing the CCD	2-19

Part ListsA-1

Part List Illustration Location	A-2
Top	A-3
Bottom	A-4

COMBO	A-5
DVD DUAL	A-6
Dummy ODD	A-7
LCD	A-8

Schematic Diagrams.....B-1

System Block Diagram	B-2
Processor 1/7-DMI, FDI, PEG	B-3
Processor 2/7- CLK, MISC	B-4
Processor 3/7- (DDR3)	B-5
Processor 4/7- Power	B-6
Processor 5/7- GFX PWR	B-7
Processor 6/7- GND	B-8
Processor 7/7- RSVD	B-9
DDR3 SO-DIMM_0	B-10
DDR3 SO-DIMM_1	B-11
PANEL, INVERTER, CRT	B-12
PCH 1/9- RTC, HDA, SATA	B-13
PCH 2/9- PCIE, SMBUS, CLK	B-14
PCH 3/9- DMI, FDI, PWRGD	B-15
PCH 4/9- LVDS, DDI, CRT	B-16
PCH 5/9- PCI, USB, RSVD	B-17
PCH 6/9- GPIO, CPU	B-18
PCH 7/9- PWR	B-19
PCH 8/9 POWER	B-20
PCH 9/9- GND	B-21
WLAN, 3G, MSATA	B-22
CCD, TPM, FAN, CLICK	B-23
USB3.0, LID SWITCH	B-24
Card Reader (RTL8411)	B-25
SATA ODD, LED, USB CHARGE	B-26

Preface

HDMI, RJ45	B-27
AUDIO CODEC VT1802P	B-28
KBC-ITE IT8518E	B-29
5VS, 3VS, 1.5VS CPU	B-30
VDD3, VDD5	B-31
Power 0.85VS, 1.8VS	B-32
POWER 1.5V/1.05VS	B-33
POWER VCORE1	B-34
POWER VCORE2	B-35
AC IN, CHARGER	B-36
AUDIO BOARD	B-37
AUDIO BOARD (W550EU)	B-38
LID SW BOARD (W550EU)	B-39
POWER SW BOARD	B-40
EXTERNAL ODD BOARD	B-41
Power Diagram	B-42
Power On SEQ	B-43
Updating the FLASH ROM BIOS.....	C-1
Download the BIOS	C-1
Unzip the downloaded files to a bootable CD/DVD/ or USB Flash drive	C-1
Set the computer to boot from the external drive	C-1
Use the flash tools to update the BIOS	C-2
Restart the computer (booting from the HDD)	C-2

Chapter 1: Introduction

Overview

This manual covers the information you need to service or upgrade the **W550EU** series notebook computer. Information about operating the computer (e.g. getting started, and the *Setup* utility) is in the *User's Manual*. Information about drivers (e.g. VGA & audio) is also found in the *User's Manual*. The manual is shipped with the computer.

Operating systems (e.g. *Windows 7*, etc.) have their own manuals as do application softwares (e.g. word processing and database programs). If you have questions about those programs, you should consult those manuals.

The **W550EU** series notebook is designed to be upgradeable. See [Disassembly on page 2 - 1](#) for a detailed description of the upgrade procedures for each specific component. Please take note of the warning and safety information indicated by the “

The balance of this chapter reviews the computer's technical specifications and features.

Introduction

Specifications



Latest Specification Information

The specifications listed here are correct at the time of sending them to the press. Certain items (particularly processor types/speeds) may be changed, delayed or updated due to the manufacturer's release schedule. Check with your service center for more details.



CPU

The CPU is not a user serviceable part. Accessing the CPU in any way may violate your warranty.

Processor Options

Intel® Core™ i7 Processor

i7-3612QM (2.10GHz)

6MB L3 Cache, 22nm, DDR3-1600MHz, TDP 35W

i7-3520M (2.90GHz)

4MB L3 Cache, 22nm, DDR3-1600MHz, TDP 35W

Intel® Core™ i5 Processor

i5-3360M (2.80GHz), i5-3320M (2.60GHz), i5-3210M (2.50GHz)

3MB L3 Cache, 22nm, DDR3-1600MHz, TDP 35W

Intel® Core™ i3 Processor

i3-3110M (2.40GHz)

3MB L3 Cache, 22nm, DDR3-1600MHz, TDP 35W

Core Logic

Intel® HM77 Chipset

BIOS

64Mb SPI Flash ROM

AMI BIOS

Memory

Two 204 Pin SO-DIMM Sockets Supporting **DDR3 1333/1600MHz** Memory

Memory Expandable up to 16GB

(The real memory operating frequency depends on the FSB of the processor.)

LCD

15.6" / 39.62cm HD / FHD, 16:9 3.8mm thick Backlit Panel

Video Adapter

Intel HD Graphics 4000

Dynamic Frequency (Intel Dynamic Video Memory Technology for up to **1.7GB**)

Microsoft DirectX®11 Compatible

Security

Security (Kensington® Type) Lock Slot

BIOS Password

Trusted Platform Module v1.2

Audio

High Definition Audio Compliant Interface

2 * Built-In Speakers

Built-In Microphone

Storage

(Factory Option) One Changeable 12.7mm(h) Optical Device Type Drive (Super Multi Drive Module or Blu-Ray Combo Drive Module)

One Changeable 2.5" 9.5mm (h) SATA HDD

(Factory Option) Dummy ODD

(Factory Option) One mSATA Solid State Drive (SSD)

Pointing Device

Built-in Touchpad

Keyboard

"WinKey" keyboard (with embedded numeric keypad)

Interface

One HDMI-Out Port

One Headphone-Out Jack

One Microphone-In Jack

One RJ-45 LAN Jack

One External Monitor Port

Two USB 2.0 Ports

Two USB 3.0 Ports

One DC-in Jack

Mini Card Slots

Slot 1 for WLAN Module or Combo WLAN and Bluetooth Module

(Factory Option) Slot 2 for 3.75G/HSPA Module OR mSATA SSD

Card Reader

Embedded Multi-In-1 Card Reader

MMC (MultiMedia Card) / RS MMC

SD (Secure Digital) / Mini SD / SDHC/ SDXC

MS (Memory Stick) / MS Pro / MS Duo

Communication

Built-In Gigabit Ethernet LAN

(Factory Option) 2M Pixel HD PC Camera Module

(Factory Option) 3.75G/HSPA Mini-Card Module

WLAN/ Bluetooth Half Mini-Card Modules:

(Factory Option) Intel® Centrino® Wireless-N 2230 Wireless LAN (**802.11b/g/n**) + Bluetooth 4.0

(Factory Option) Intel® Centrino® Wireless-N 135 Wireless LAN (**802.11b/g/n**) + Bluetooth 4.0

(Factory Option) Third-Party Wireless LAN (**802.11b/g/n**)

(Factory Option) Third-Party Wireless LAN (**802.11b/g/n**) + Bluetooth 4.0

Power

6 Cell Smart Lithium-Ion Battery Pack, 48.84WH

(Factory Option) 6 Cell Smart Lithium-Ion Battery Pack, 62.16WH

Full Range AC/DC Adapter

AC Input: 100 - 240V, 50 - 60Hz

DC Output: 19V, 3.42A or 18.5V, 3.5A (**65W**)

Environmental Spec

Temperature

Operating: 5°C - 35°C

Non-Operating: -20°C - 60°C

Relative Humidity

Operating: 20% - 80%

Non-Operating: 10% - 90%

Dimensions & Weight

374mm(w) * 252mm(d) * 14 - 25.4mm(h)

(Height excluding battery area)

2.2kg with 48.84WH Battery & ODD

Introduction

Figure 1
Top View

1. PC Camera
(Optional)
2. Built-In
Microphone
3. LCD
4. Power Button
5. Keyboard
6. Touchpad &
Buttons

External Locator - Top View with LCD Panel Open



External Locator - Front & Right Side Views

FRONT VIEW



Figure 2
Front View

1. LED Power Indicator
2. Multi-in-1 Card Reader

RIGHT SIDE VIEW



Figure 3
Right Side View

1. Microphone-In Jack
2. Headphone-Out Jack
3. USB 2.0 Ports
4. Optical Device Drive Bay
5. Emergency Eject Hole
6. Security Lock Slot

Introduction

External Locator - Left Side & Rear View

Figure 4
Left Side View

1. DC-In Jack
2. RJ-45 LAN Jack
3. External Monitor Port
4. Vent
5. HDMI-Out Port
6. USB 3.0 Ports

LEFT SIDE VIEW



Figure 5
Rear View

1. Battery

REAR VIEW



External Locator - Bottom View

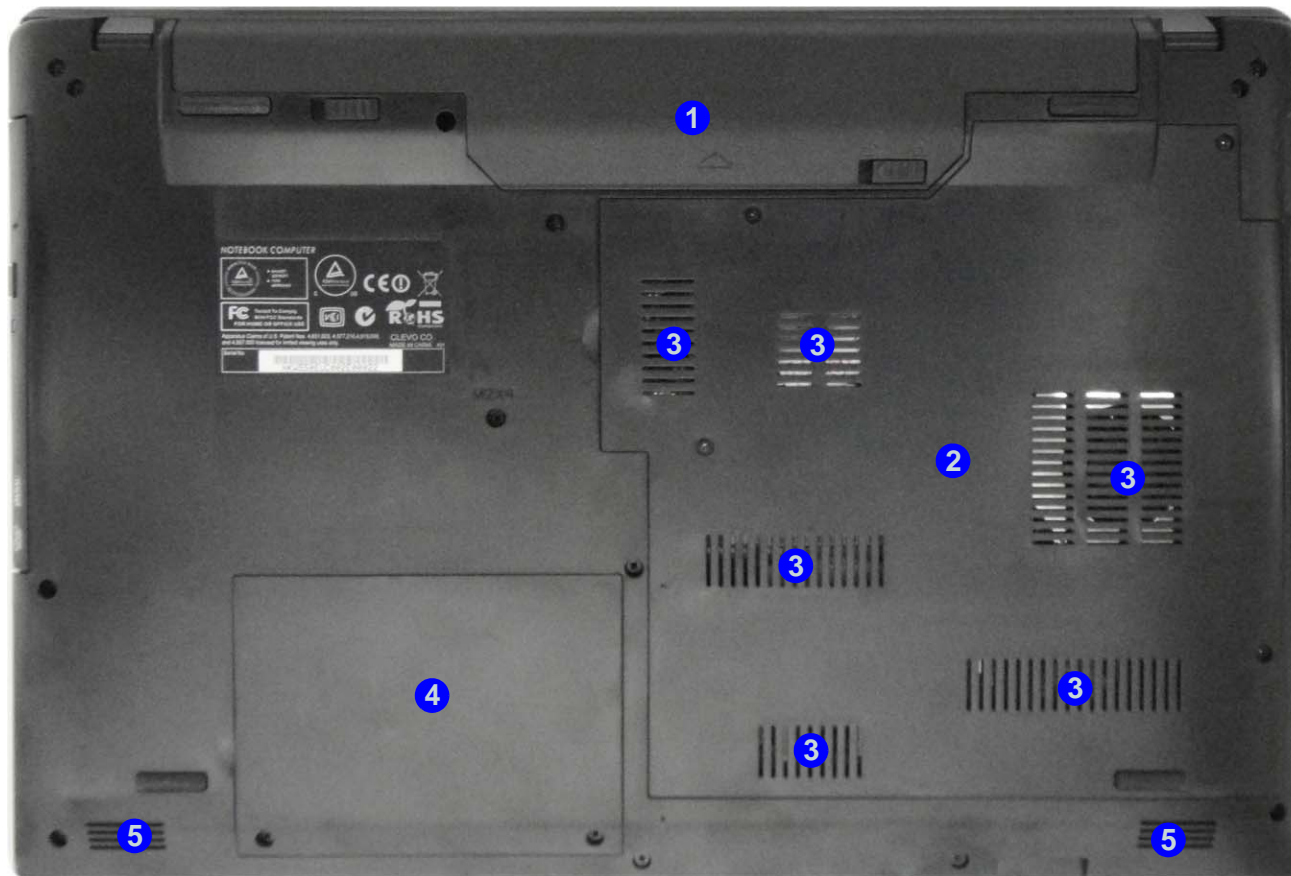

Figure 6
Bottom View

1. Battery
2. Component Bay Cover
3. Vent
4. Hard Disk Bay Cover
5. Speakers



Overheating

To prevent your computer from overheating, make sure nothing blocks any vent while the computer is in use.

Introduction

Figure 7
Mainboard Top
Key Parts

1. KBC-ITE IT8518

Mainboard Overview - Top (Key Parts)



Mainboard Overview - Bottom (Key Parts)

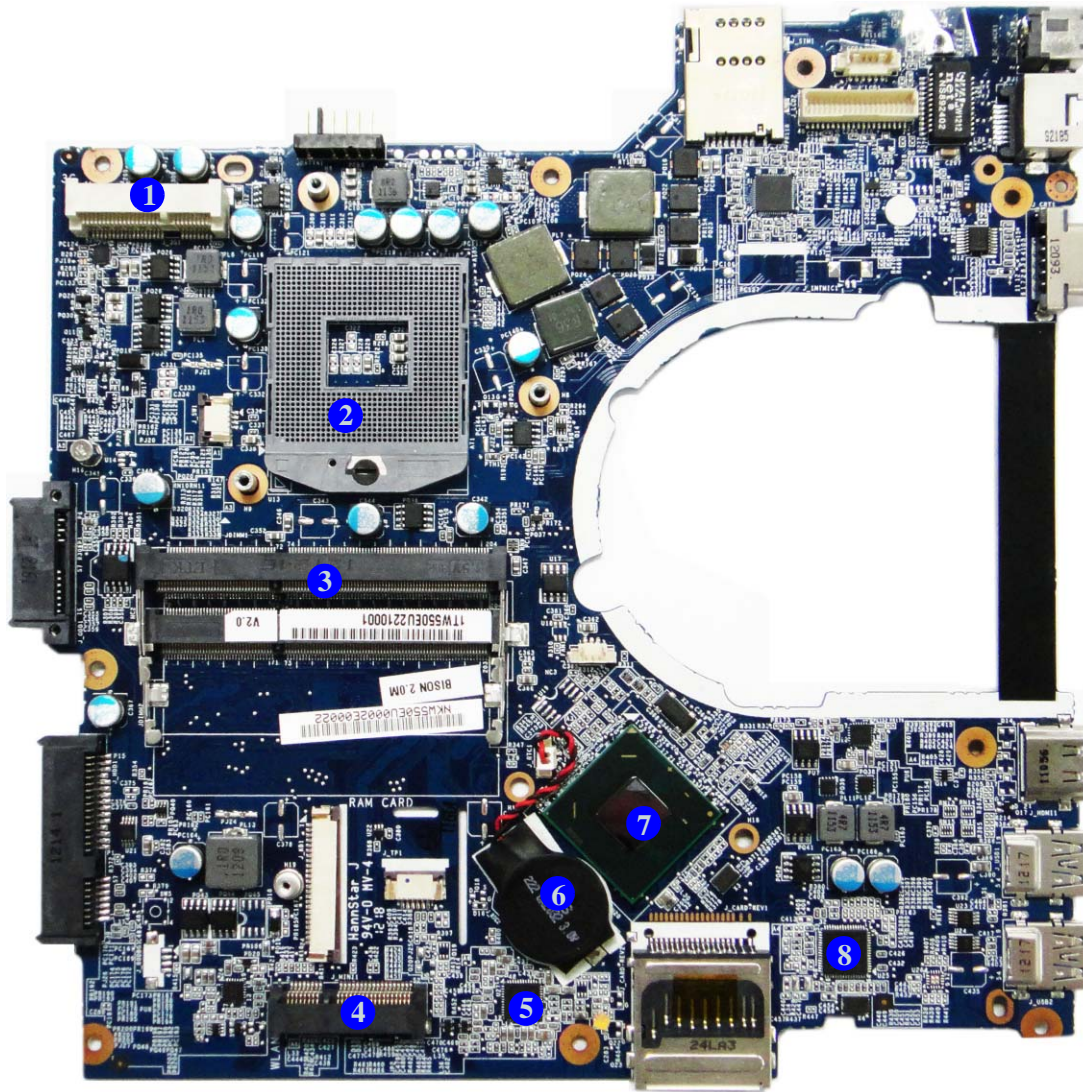

Figure 8
Mainboard Bottom
Key Parts

1. Mini-Card Connector (3G Module)
2. CPU Socket (no CPU installed)
3. Memory Slots (DDR3 SO-DIMM)
4. Mini-Card Connector (WLAN Module)
5. Audio Codec VIA 1802P
6. CMOS Battery
7. Platform Controller Hub
8. LAN + Card Reader IC (RTL8411)

Introduction

Figure 9
**Mainboard Top
Connectors**

1. HDMI-Out Port
2. USB Port 3.0
3. **Speaker** Cable Connector
4. **Microphone** Cable Connector
5. USB Port 2.0 Connector

Mainboard Overview - Top (Connectors)



Mainboard Overview - Bottom (Connectors)

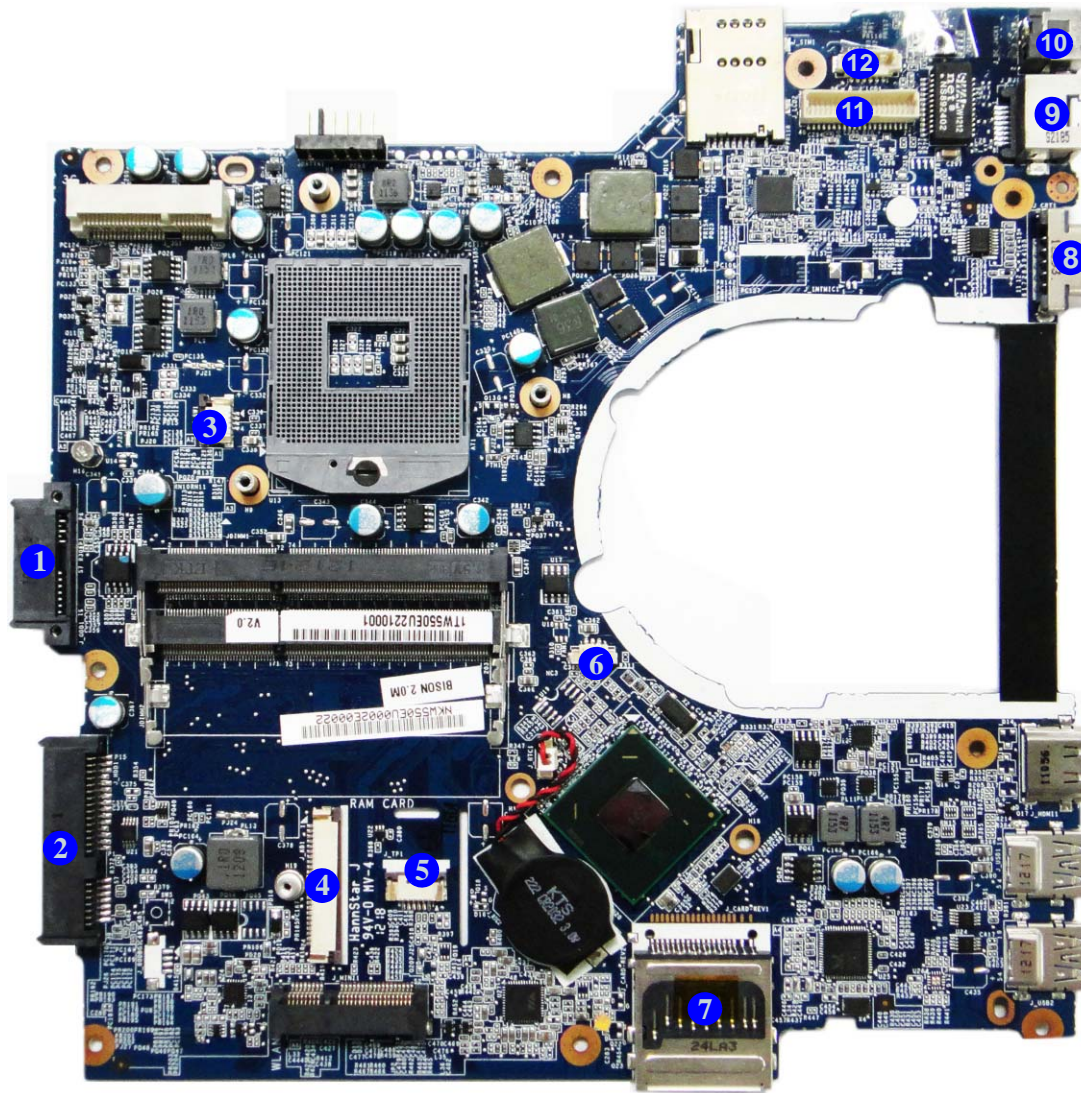

Figure 10
**Mainboard Bottom
Connectors**

1. ODD Connector
2. HDD Connector
3. Power Button Cable Connector
4. Keyboard Cable Connector
5. TouchPad Cable Connector
6. Fan Cable Connector
7. Multi-in-1 Card Reader
8. External Monitor Port
9. RJ-45 LAN Jack
10. DC-In Jack
11. LCD Cable Connector
12. CCD Cable Connector

Chapter 2: Disassembly

Overview

This chapter provides step-by-step instructions for disassembling the *W550EU* series notebook's parts and subsystems. When it comes to reassembly, reverse the procedures (unless otherwise indicated).

We suggest you completely review any procedure before you take the computer apart.

Procedures such as upgrading/replacing the RAM, optical device and hard disk are included in the User's Manual but are repeated here for your convenience.

To make the disassembly process easier each section may have a box in the page margin. Information contained under the figure # will give a synopsis of the sequence of procedures involved in the disassembly procedure. A box with a  lists the relevant parts you will have after the disassembly process is complete. **Note:** The parts listed will be for the disassembly procedure listed ONLY, and not any previous disassembly step(s) required. Refer to the part list for the previous disassembly procedure. The amount of screws you should be left with will be listed here also.

A box with a  will also provide any possible helpful information. A box with a  contains warnings.

An example of these types of boxes are shown in the sidebar.

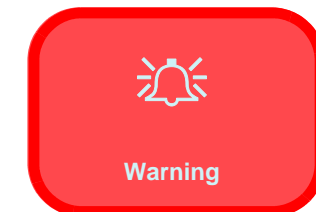
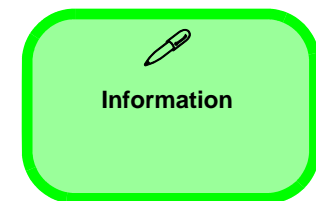

Disassembly

NOTE: All disassembly procedures assume that the system is turned **OFF**, and disconnected from any power supply (the battery is removed too).

Maintenance Tools

The following tools are recommended when working on the notebook PC:

- M3 Philips-head screwdriver
- M2.5 Philips-head screwdriver (magnetized)
- M2 Philips-head screwdriver
- Small flat-head screwdriver
- Pair of needle-nose pliers
- Anti-static wrist-strap

Connections

Connections within the computer are one of four types:

Locking collar sockets for ribbon connectors	To release these connectors, use a small flat-head screwdriver to gently pry the locking collar away from its base. When replacing the connection, make sure the connector is oriented in the same way. The pin1 side is usually not indicated.
Pressure sockets for multi-wire connectors	To release this connector type, grasp it at its head and gently rock it from side to side as you pull it out. Do not pull on the wires themselves. When replacing the connection, do not try to force it. The socket only fits one way.
Pressure sockets for ribbon connectors	To release these connectors, use a small pair of needle-nose pliers to gently lift the connector away from its socket. When replacing the connection, make sure the connector is oriented in the same way. The pin1 side is usually not indicated.
Board-to-board or multi-pin sockets	To separate the boards, gently rock them from side to side as you pull them apart. If the connection is very tight, use a small flat-head screwdriver - use just enough force to start.

Maintenance Precautions

The following precautions are a reminder. To avoid personal injury or damage to the computer while performing a removal and/or replacement job, take the following precautions:

1. **Don't drop it.** Perform your repairs and/or upgrades on a stable surface. If the computer falls, the case and other components could be damaged.
2. **Don't overheat it.** Note the proximity of any heating elements. Keep the computer out of direct sunlight.
3. **Avoid interference.** Note the proximity of any high capacity transformers, electric motors, and other strong magnetic fields. These can hinder proper performance and damage components and/or data. You should also monitor the position of magnetized tools (i.e. screwdrivers).
4. **Keep it dry.** This is an electrical appliance. If water or any other liquid gets into it, the computer could be badly damaged.
5. **Be careful with power.** Avoid accidental shocks, discharges or explosions.
 - Before removing or servicing any part from the computer, turn the computer off and detach any power supplies.
 - When you want to unplug the power cord or any cable/wire, be sure to disconnect it by the plug head. Do not pull on the wire.
6. **Peripherals** – Turn off and detach any peripherals.
7. **Beware of static discharge.** ICs, such as the CPU and main support chips, are vulnerable to static electricity. Before handling any part in the computer, discharge any static electricity inside the computer. When handling a printed circuit board, do not use gloves or other materials which allow static electricity buildup. We suggest that you use an anti-static wrist strap instead.
8. **Beware of corrosion.** As you perform your job, avoid touching any connector leads. Even the cleanest hands produce oils which can attract corrosive elements.
9. **Keep your work environment clean.** Tobacco smoke, dust or other air-borne particulate matter is often attracted to charged surfaces, reducing performance.
10. **Keep track of the components.** When removing or replacing any part, be careful not to leave small parts, such as screws, loose inside the computer.

Cleaning

Do not apply cleaner directly to the computer, use a soft clean cloth.

Do not use volatile (petroleum distillates) or abrasive cleaners on any part of the computer.



Power Safety Warning

Before you undertake any upgrade procedures, make sure that you have turned off the power, and disconnected all peripherals and cables (including telephone lines and power cord). It is advisable to also remove your battery in order to prevent accidentally turning the machine on.

Disassembly Steps

The following table lists the disassembly steps, and on which page to find the related information. **PLEASE PERFORM THE DISASSEMBLY STEPS IN THE ORDER INDICATED.**

To remove the Battery:

1. Remove the battery *page 2 - 5*

To remove the HDD:

1. Remove the battery *page 2 - 5*
2. Remove the HDD *page 2 - 6*

To remove the Optical Device:

1. Remove the battery *page 2 - 5*
2. Remove the Optical device *page 2 - 8*

To remove the System Memory:

1. Remove the battery *page 2 - 5*
2. Remove the system memory *page 2 - 10*

To remove and install a Processor:

1. Remove the battery *page 2 - 5*
2. Remove the processor *page 2 - 12*
3. Install the processor *page 2 - 14*

To remove the Wireless LAN Module & Keyboard:

1. Remove the battery *page 2 - 5*
2. Remove the WLAN & keyboard *page 2 - 15*

To remove the 3.75G Module:

1. Remove the battery *page 2 - 5*
2. Remove the 3.75G module *page 2 - 18*

To remove the CCD Module:

1. Remove the battery *page 2 - 5*
2. Remove the CCD module *page 2 - 19*

Removing the Battery

1. Turn the computer **off**, and turn it over.
2. Slide the latch **1** in the direction of the arrow (*Figure 1a*).
3. Slide the latch **2** in the direction of the arrow, and hold it in place (*Figure 1a*).
4. Slide the battery **3** in the direction of the arrow **4** (*Figure 1b*).

a.

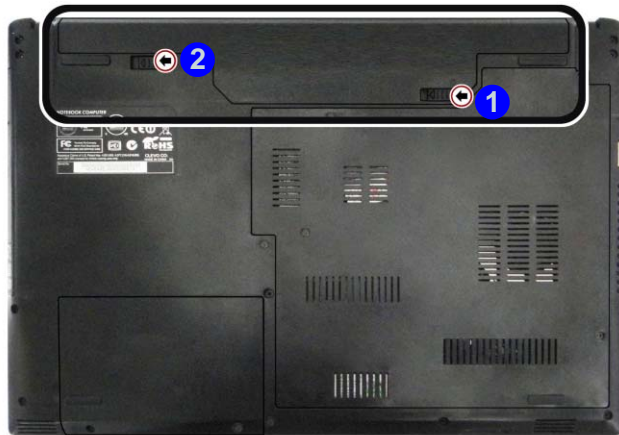

b.

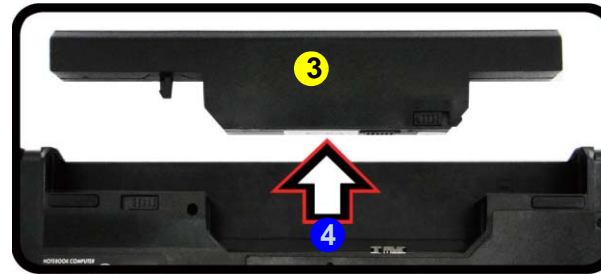
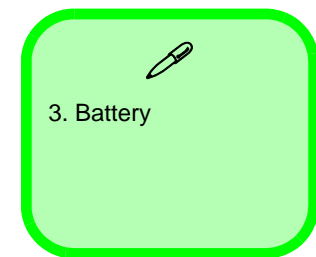

Figure 1
Battery Removal

- a. Slide the latch and hold it in place.
- b. Slide the battery in the direction of the arrow.



Removing the Hard Disk Drive

Figure 2
**HDD Assembly
Removal**

The hard disk drive can be taken out to accommodate other 2.5" serial (SATA) hard disk drives with a height of 9.5mm (h). Follow your operating system's installation instructions, and install all necessary drivers and utilities (as outlined in **Chapter 4 of the User's Manual**) when setting up a new hard disk.

- a. Locate the HDD bay cover and remove the screws.

Hard Disk Upgrade Process

1. Turn **off** the computer, and remove the battery ([page 2 - 5](#)).
2. Locate the hard disk bay cover and remove screws **1** & **2** ([Figure 2a](#)).

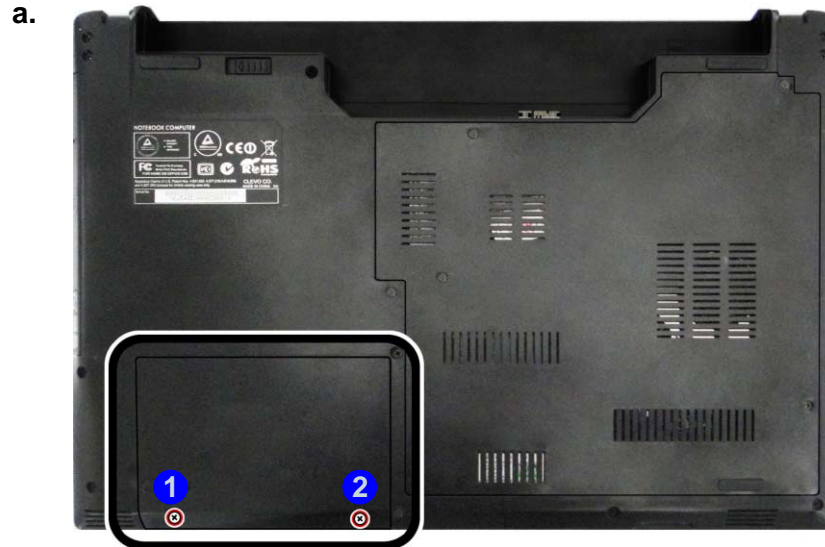

HDD System Warning

New HDD's are blank. Before you begin make sure:

You have backed up any data you want to keep from your old HDD.

You have all the CD-ROMs and FDDs required to install your operating system and programs.

If you have access to the internet, download the latest application and hardware driver updates for the operating system you plan to install. Copy these to a removable medium.



- 2 Screws

- Lift the hard disk bay cover from point **3** (*Figure 3b*).
- Remove the hard disk bay cover **4** (*Figure 3b*).
- Grip the tab and slide the hard disk assembly in the direction of arrow **5** (*Figure 3c*).
- Lift the hard disk assembly **6** out of the bay **7** (*Figure 3d*).
- Remove the screws **8** - **9** and the adhesive cover **10** from the hard disk **11** (*Figure 3e*).
- Reverse the process to install a new hard disk (do not forget to replace all the screws and bay cover).

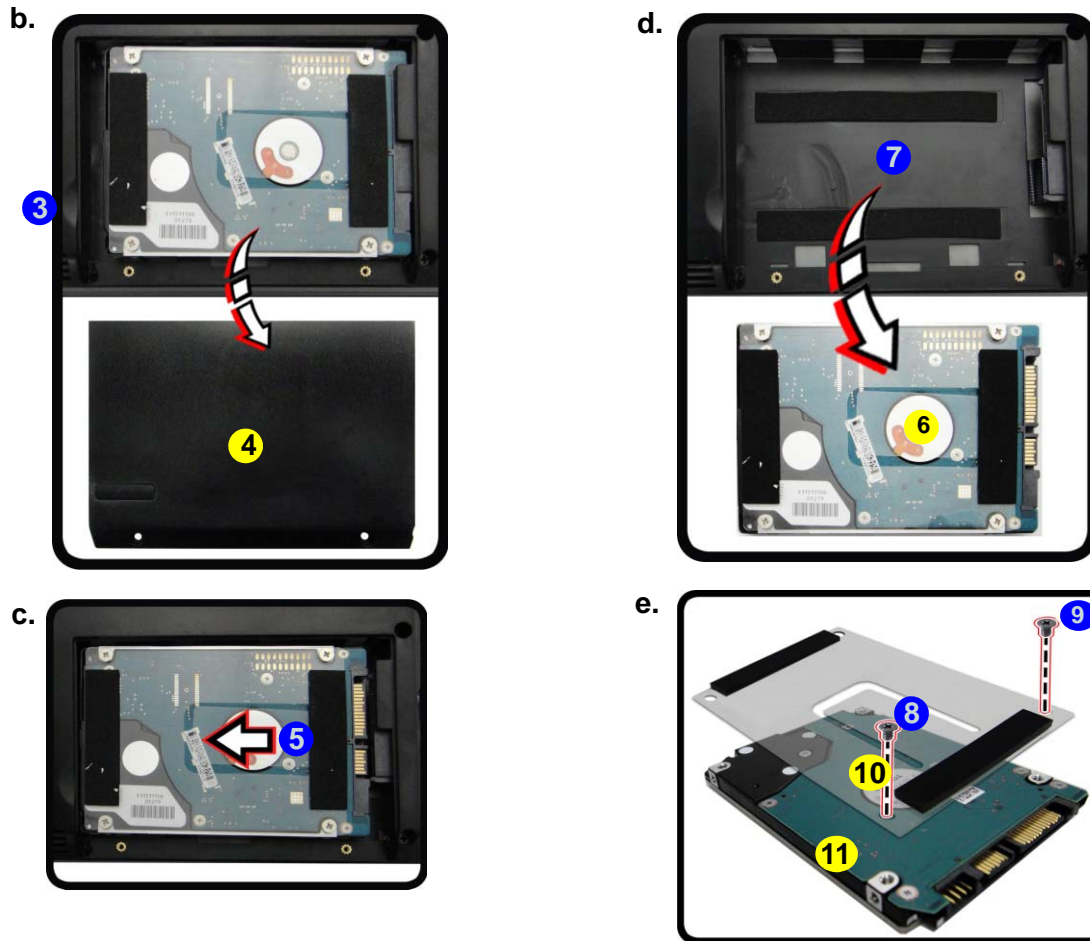

Figure 3
**HDD Assembly
Removal (cont'd.)**

- Remove the HDD bay cover.
- Grip the tab and slide the HDD assembly in the direction of the arrow.
- Lift the HDD assembly out of the bay.
- Remove the screws and adhesive cover.



Disassembly

Figure 4 Optical Device Removal

- Remove the screws.
- Remove the component bay cover.

Removing the Optical (CD/DVD) Device

- Turn **off** the computer, and remove the battery ([page 2 - 5](#)).
- Locate the component bay cover and remove screws **1** - **4** ([Figure 4a](#)).
- Remove the component bay cover **5** ([Figure 4b](#)).

a.

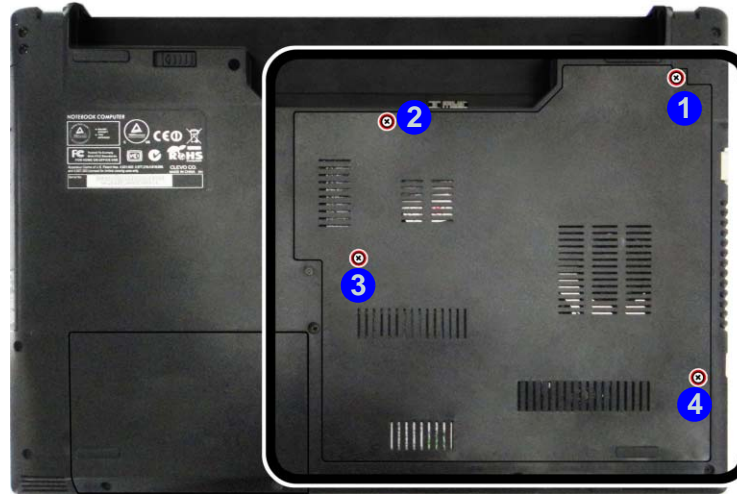

b.

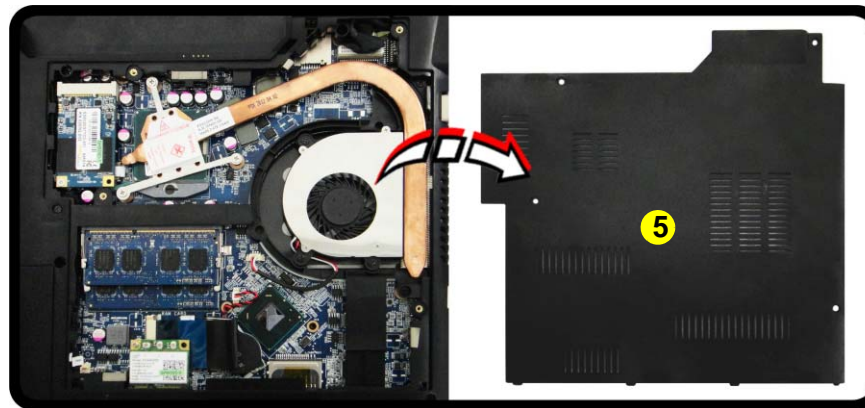

5. Component Bay Cover

- 4 Screws

4. Remove the screw at point 6 (Figure 5c).
5. Use a screwdriver to carefully push out the optical device 8 at point 7 (Figure 5d).
6. Insert the new device and carefully slide it into the computer (the device only fits one way. DO NOT FORCE IT; The screw holes should line up).
7. Replace the component bay cover and screws.
8. Restart the computer to allow it to automatically detect the new device.

Figure 5
Optical Device
Removal (cont'd.)

- c. Remove the screw at point 6.
- d. Use a screwdriver to carefully push out the optical device at point 7.

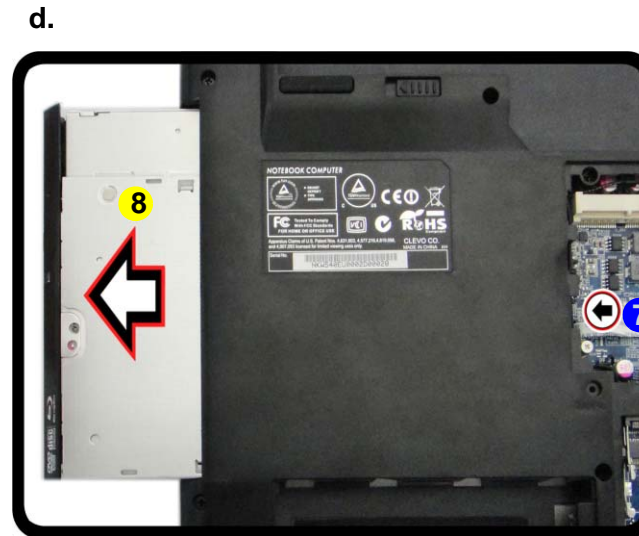

8. Optical Device

- 1 Screw

Disassembly

Figure 6
RAM Module Removal

- Remove the screws from the component bay cover.
- Remove the component bay cover. The RAM modules will be visible at point **6** on the mainboard.



Contact Warning

Be careful not to touch the metal pins on the module's connecting edge. Even the cleanest hands have oils which can attract particles, and degrade the module's performance.



5. Component Bay Cover

- 4 Screws

Removing the System Memory (RAM)

The computer has two memory sockets for 204 pin Small Outline Dual In-line Memory Modules (SO-DIMM) supporting DDRIII (DDR3) Up to 1066/1333 MHz. The main memory can be expanded up to 8GB. The SO-DIMM modules supported are 1024MB and 2048MB **DDRIII** Modules. The total memory size is automatically detected by the POST routine once you turn on your computer.

Memory Upgrade Process

- Turn **off** the computer, turn it over, and remove the battery ([page 2 - 5](#)).
- Remove screws **1** - **4** from the component bay cover ([Figure 6a](#)).
- Carefully lift up the bay cover **5**.
- The RAM modules will be visible at point **6** on the mainboard ([Figure 6b](#)).

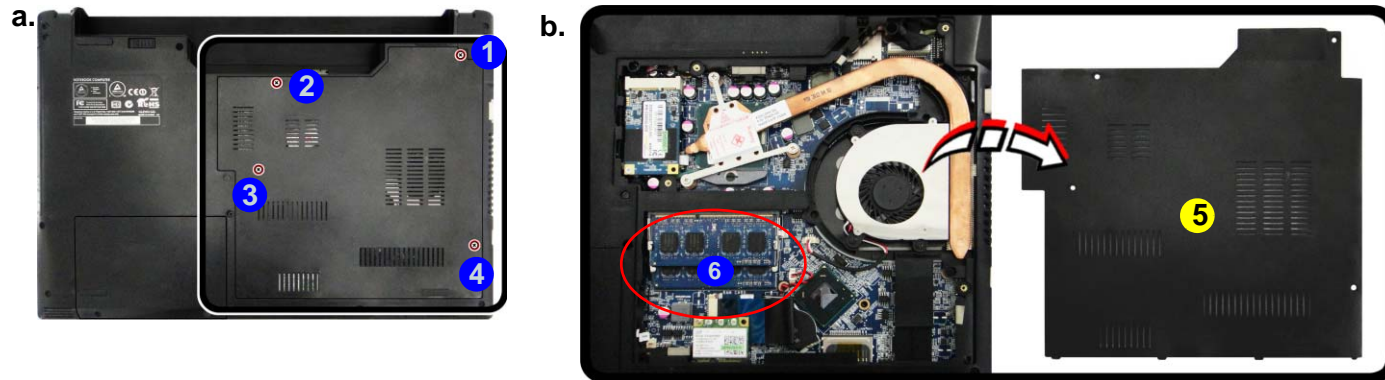

- Gently pull the two release latches (7 & 8) on the sides of the memory socket in the direction indicated by the arrows (Figure 7c). The RAM module 9 will pop-up (Figure 7d), and you can then remove it.
- Pull the latches to release the second module if necessary.
- Insert a new module holding it at about a 30° angle and fit the connectors firmly into the memory slot.
- The module will only fit one way as defined by its pin alignment. Make sure the module is seated as far into the slot as it will go. DO NOT FORCE IT; it should fit without much pressure.
- Press the module in and down towards the mainboard until the slot levers click into place to secure the module.
- Replace the component bay cover and the screws (see page 2 - 10).
- Restart the computer to allow the BIOS to register the new memory configuration as it starts up.

Figure 7
RAM Module
Removal (cont'd)

- Pull the release latches.
- Remove the module.

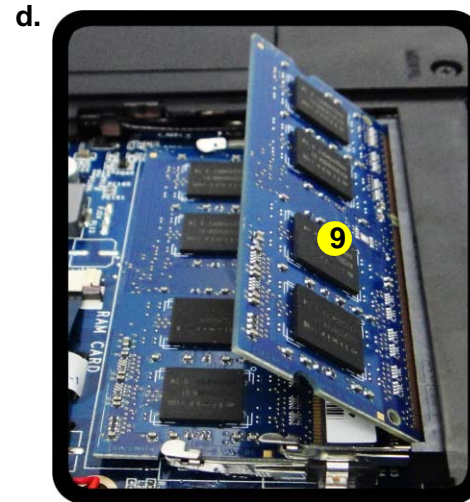
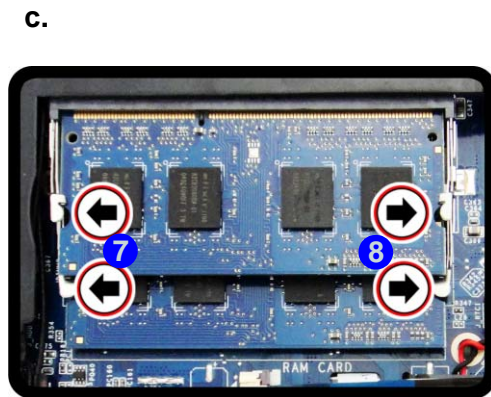



Single Memory Module Installation

If your computer has a single memory module, then insert the module into the **Channel 0 (JDIMM1)** socket. In this case this is the **lower memory socket** (the socket closest to the mainboard).



Contact Warning

Be careful not to touch the metal pins on the module's connecting edge. Even the cleanest hands have oils which can attract particles, and degrade the module's performance.



9. RAM Module

Disassembly

Figure 8
Processor Removal

Removing and Installing a Processor

Processor Removal Procedure

- Locate the CPU heat sink.
 - Disconnect the cable and remove the screws.
 - Remove the fan.
 - Remove the screws.
- Turn **off** the computer, turn it over, remove the battery ([page 2 - 5](#)) and the component bay cover ([page 2 - 8](#)).
 - The CPU heat sink will be visible at point **A** ([Figure 8a](#)).
 - Carefully disconnect the fan cable **B**, and then remove the screws **C - E** ([Figure 8b](#)).
 - Lift the fan **F** out of the bay ([Figure 8c](#)).
 - Loosen the CPU heat sink screws in the order **3**, **2** & **1** (the reverse order as indicated on the label [Figure 8d](#)).

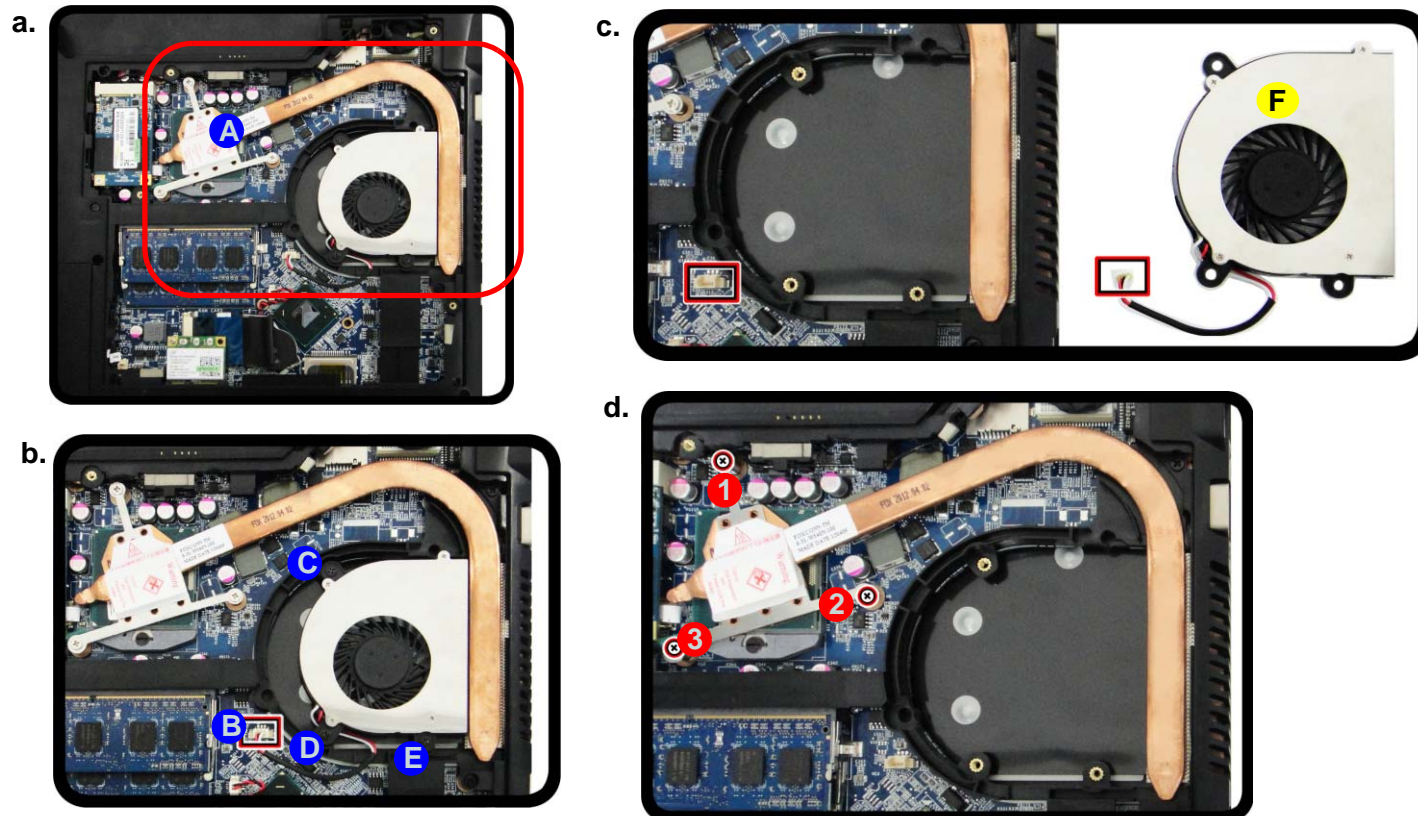

F. Fan

- 6 Screws



- Carefully (it may be hot) remove the heat sink unit **G** off the computer (*Figure 9e*).
- Turn the release latch **H** towards the unlock symbol  to release the CPU (*Figure 9f*).
- Carefully (it may be hot) lift the CPU **I** up and out of the socket (*Figure 9g*).
- Reverse the process to install a new CPU.
- When re-inserting the CPU, pay careful attention to the pin alignment, it will fit only one way (DO NOT FORCE IT!)

Figure 9
Processor Removal
(cont'd)

- Carefully remove the heat sink unit.
- Turn the release latch to unlock the CPU.
- Lift the CPU out of the socket.

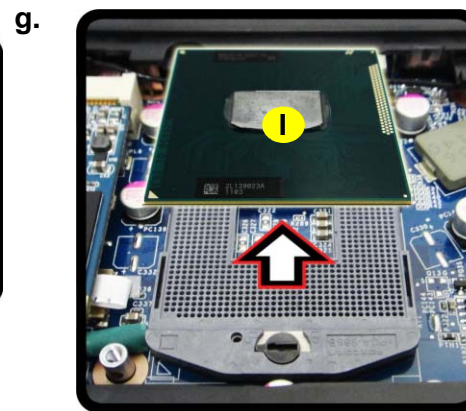
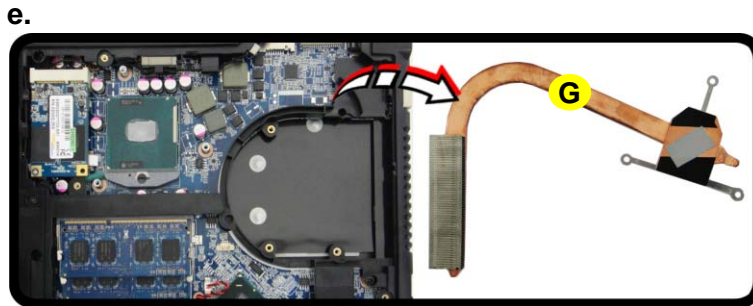

Caution
The heat sink, and CPU area in general, contains parts which are subject to high temperatures. Allow the area time to cool before removing these parts.



G. Heat Sink
I. CPU

Disassembly

Figure 10
Processor Installation

- Insert the CPU.
- Turn the release latch towards the lock symbol.
- Insert the heat sink.
- Tighten the screws.

Processor Installation Procedure

- Insert the CPU **A** (*Figure 10a*), and pay careful attention to the pin alignment; it will fit only one way (DO NOT FORCE IT!), and turn the release latch **B** towards the lock symbol  (*Figure 10b*).
- Remove the sticker **C** (*Figure 10c*) from the heat sink unit.
- Insert the heat sink **D** as indicated in *Figure 10c*.
- Tighten the CPU heat sink screws in the order **1**, **2** & **3** (the order as indicated on the label and *Figure 10d*).
- Replace the CPU fan, component bay cover and tighten the screws (*page 2 - 12*).

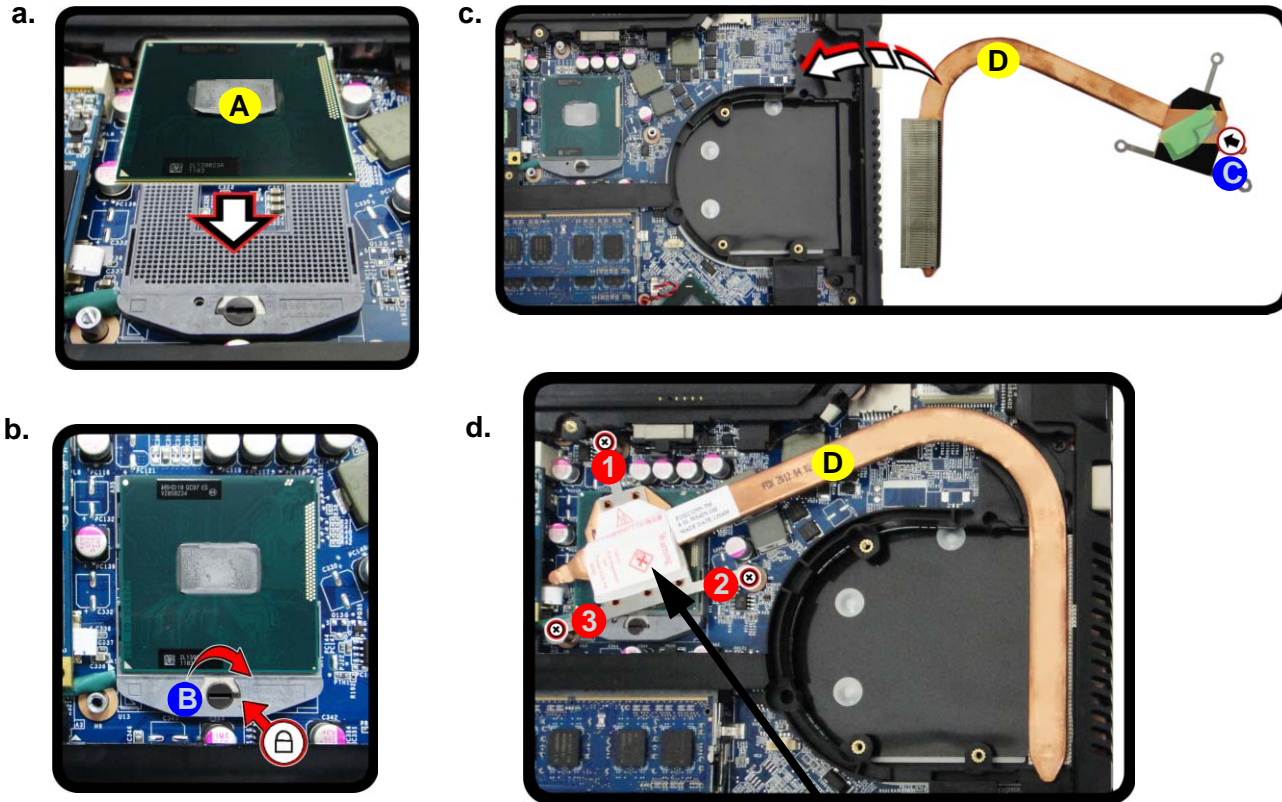

A. CPU
D. Heat Sink

- 3 Screws

Note:
Tighten the screws in the order as indicated on the label.

Removing the Wireless LAN Module and Keyboard

1. Turn **off** the computer, turn it over, remove the battery ([page 2 - 5](#)) and the component bay cover ([page 2 - 8](#)).
2. The Wireless LAN module will be visible at point **1** on the mainboard and keyboard ribbon cable under the Wireless LAN module ([Figure 11a](#)).
3. Carefully disconnect the cable **2**, and then remove the screw **3** ([Figure 11b](#)).
4. The Wireless LAN module **4** ([Figure 11c](#)) will pop-up, and you can remove it from the computer and the keyboard ribbon cable will be visible at point **5**.
5. Careful not to bend the keyboard ribbon cable **6**. Disconnect the keyboard ribbon cable from the locking collar socket **7** ([Figure 11d](#)).

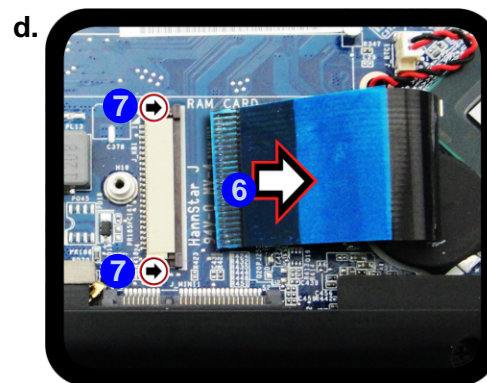
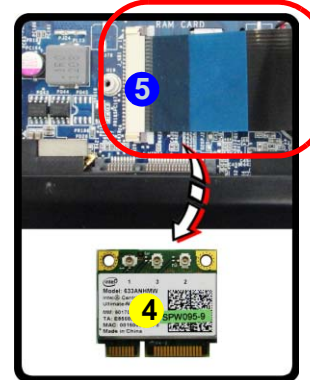



Touchpad Cable

The touchpad cable is underneath the keyboard cable. When disassembling the mainboard, the touchpad cable must be disconnected.



4. Wireless LAN Module

- 1 Screw

Figure 11
Wireless LAN Module and Keyboard Removal

- a. Locate the WLAN.
- b. Disconnect the cable and remove the screw.
- c. The WLAN module will pop up.
- d. Disconnect the keyboard ribbon cable from the locking collar socket.

Note: Make sure you reconnect the antenna cable to the “1 + 2” socket ([Figure 11b](#)).

Disassembly

Figure 12
Keyboard Removal

- e. Disconnect the cables.
f. Remove the screws.
g. Pry the top case off the bottom case.
h. Separate the top and bottom case.

6. Disconnect cables **8** - **9** (Figure 12e).
7. Remove screws **10** - **25** from the bottom case.
8. Turn the computer over, carefully pry the top case **26** off the bottom case at points **A** - **C** (Figure 12g).
9. Separate the top case **26** up and off the bottom case (Figure 12h)

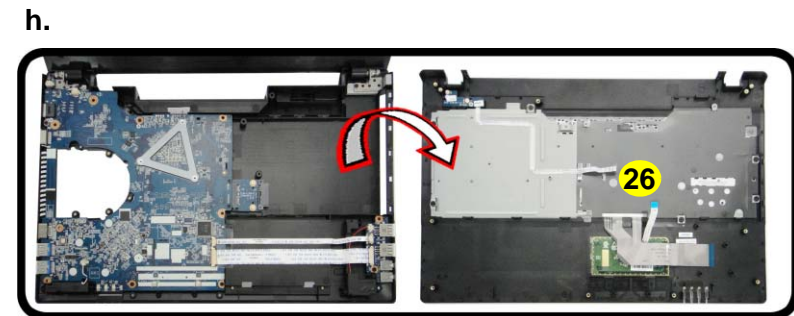
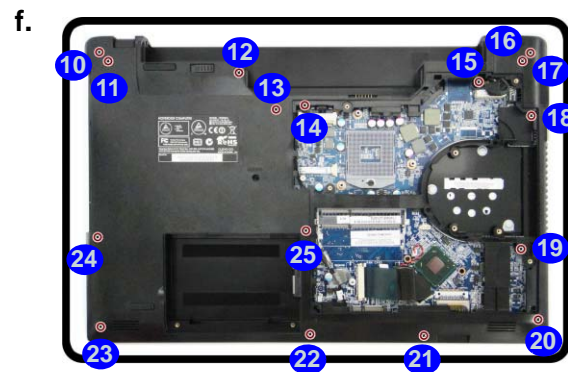
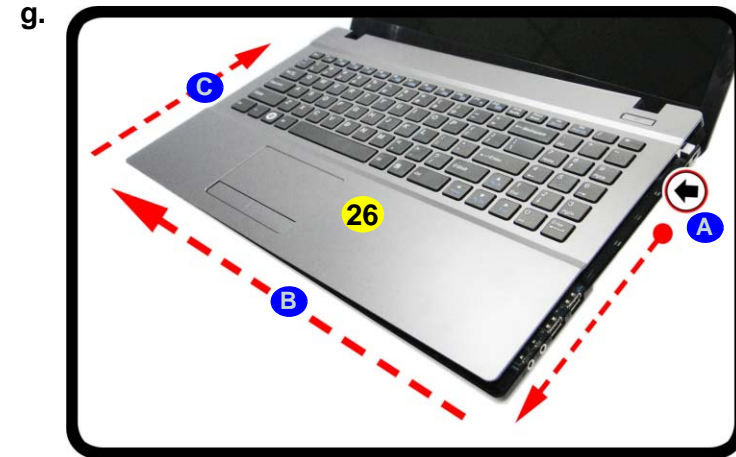
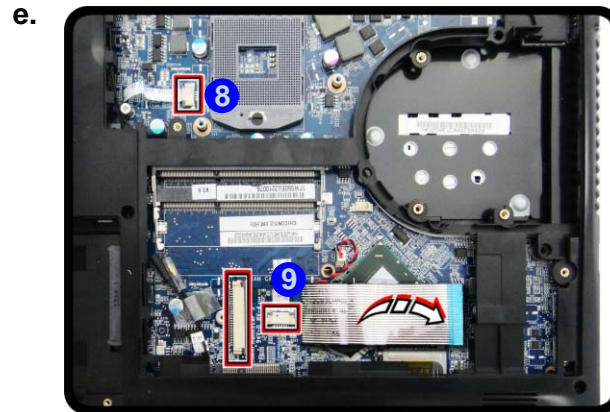

26. Top Case

- 16 Screws

10. Remove screws 27 - 32 from the top case.
11. Remove screws 33 - 41 from the keyboard shielding plate (**Note:** when removing special screws 33 - 41, you'll need to use an (#0 head) electric screwdriver - set to a low spin of 300r.p.m. and low torque at 0.1~1.5kgf.cm. The Lock torque should be set to 0.35~0.45kgf.cm, and should not be exceeded or it may cause screw damage).
12. Carefully lift the keyboard shielding plate 42 .
13. Carefully separate the keyboard 43 from the top case (*Figure 13k*).

Figure 13
Keyboard Removal (cont'd)

- i. Remove the screws.
- j. Lift the keyboard shielding plate.
- k. Separate the keyboard from the top case.

i.

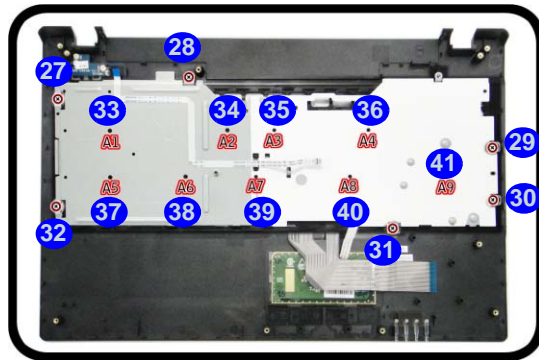

j.



k.





42.Keyboard Shielding Plate
43.Keyboard

- 15 Screws

Disassembly

Figure 14
3G Module Removal

- Locate the 3.75G module.
- Remove the screw.
- The module will pop-up.
- Remove the 3.75G module.

Removing the 3.75G Module

- Turn **off** the computer, turn it over, remove the battery ([page 2 - 12](#)) and the component bay cover ([page 2 - 10](#)).
- The 3.75G module will be visible at point **1** on the mainboard ([Figure 14a](#)).
- Carefully remove the screw **2** ([Figure 14b](#)).
- The 3.75G module **3** ([Figure 14c](#)) will pop-up, and you can remove it from the computer ([Figure 14d](#)).

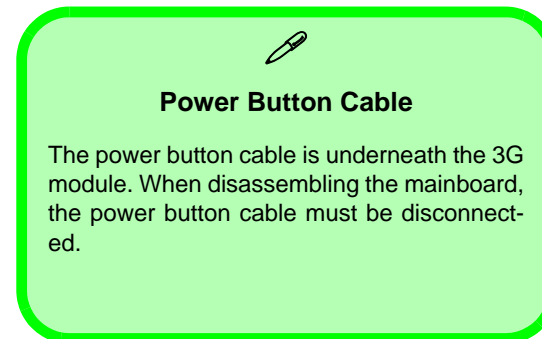
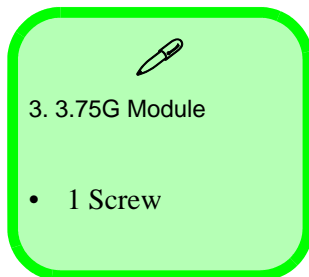
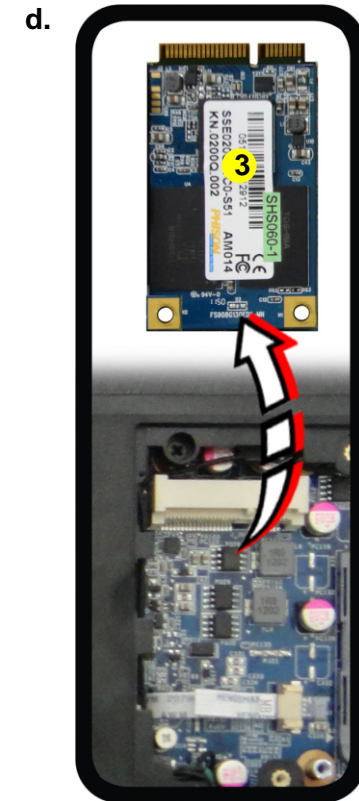
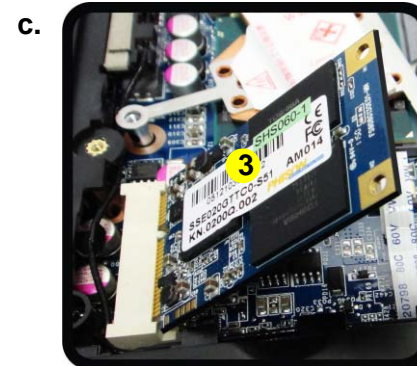
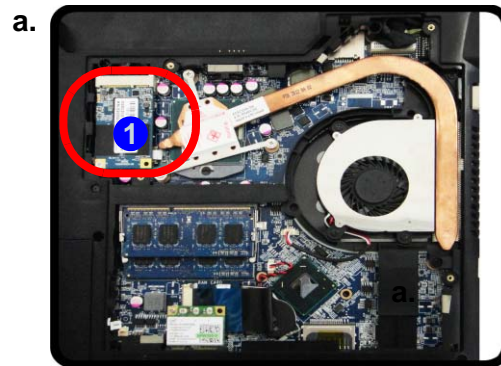

Removing the CCD

1. Turn **off** the computer, turn it over, and remove the battery ([page 2 - 12](#)).
2. Carefully remove the rubber screw covers **1** - **4** and screws **5** - **8** from the front cover ([Figure 15a](#)).
3. Run your fingers around the inner frame of the LCD panel at the points as indicated by the arrows **9** - **12**.
4. Lay the computer down on a flat surface with the top case up forming a 90 degree angle. Push the LCD front cover **13** upwards before carefully lifting it up.
5. Remove the LCD front cover **13** ([Figure 15c](#)).

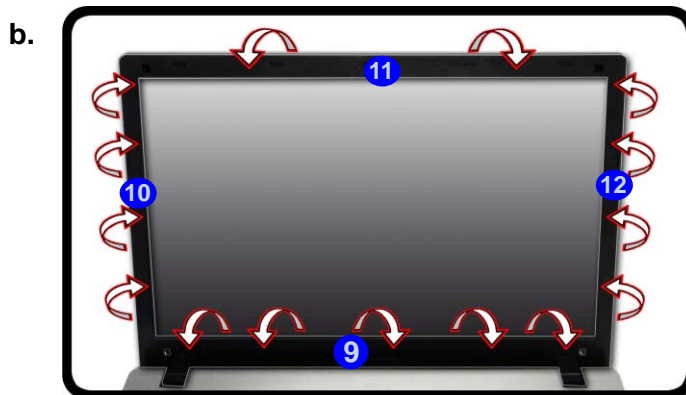
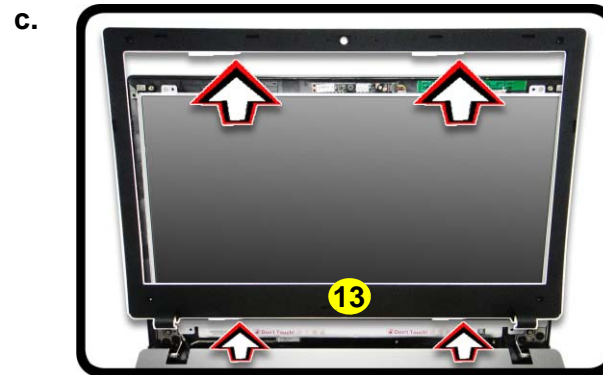

Figure 15
CCD Removal

- a. Carefully remove the rubber screw covers and screws from the front cover.
- k. Run your fingers around the inner frame of the LCD panel at the points indicated by the arrows.
- l. Lay the computer down on a flat surface with the top case up forming a 90 degree angle. Push the LCD front panel upwards before carefully lifting it up.
- d. Remove the LCD front cover.



13. LCD Front Cover

- 4 Screws

Disassembly

Figure 16
CCD Removal
(cont'd)

- e. Disconnect the cable.
- f. Remove the CCD module.

- 6. Disconnect the cable **14**.
- 7. Remove the CCD module **15** (*Figure 16f*).
- 8. Reverse the process to install a new CCD module.

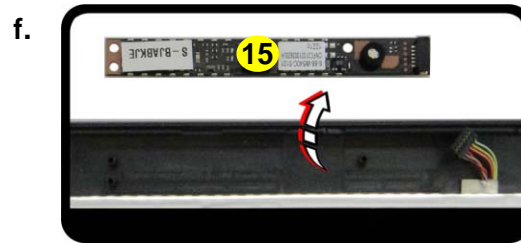

15. CCD Module

Appendix A:Part Lists

This appendix breaks down the *W550EU* series notebook's construction into a series of illustrations. The component part numbers are indicated in the tables opposite the drawings.

Note: This section indicates the *manufacturer's* part numbers. Your organization may use a different system, so be sure to cross-check any relevant documentation.

Note: Some assemblies may have parts in common (especially screws). However, the part lists DO NOT indicate the total number of duplicated parts used.

Note: Be sure to check any update notices. The parts shown in these illustrations are appropriate for the system at the time of publication. Over the product life, some parts may be improved or re-configured, resulting in *new* part numbers.

Part List Illustration Location

The following table indicates where to find the appropriate part list illustration.

Table A - 1
**Part List Illustration
Location**

Part	
Top	<i>page A - 3</i>
Bottom	<i>page A - 4</i>
COMBO	<i>page A - 5</i>
DVD Dual Drive	<i>page A - 6</i>
Dummy ODD	<i>page A - 7</i>
LCD	<i>page A - 8</i>

Top

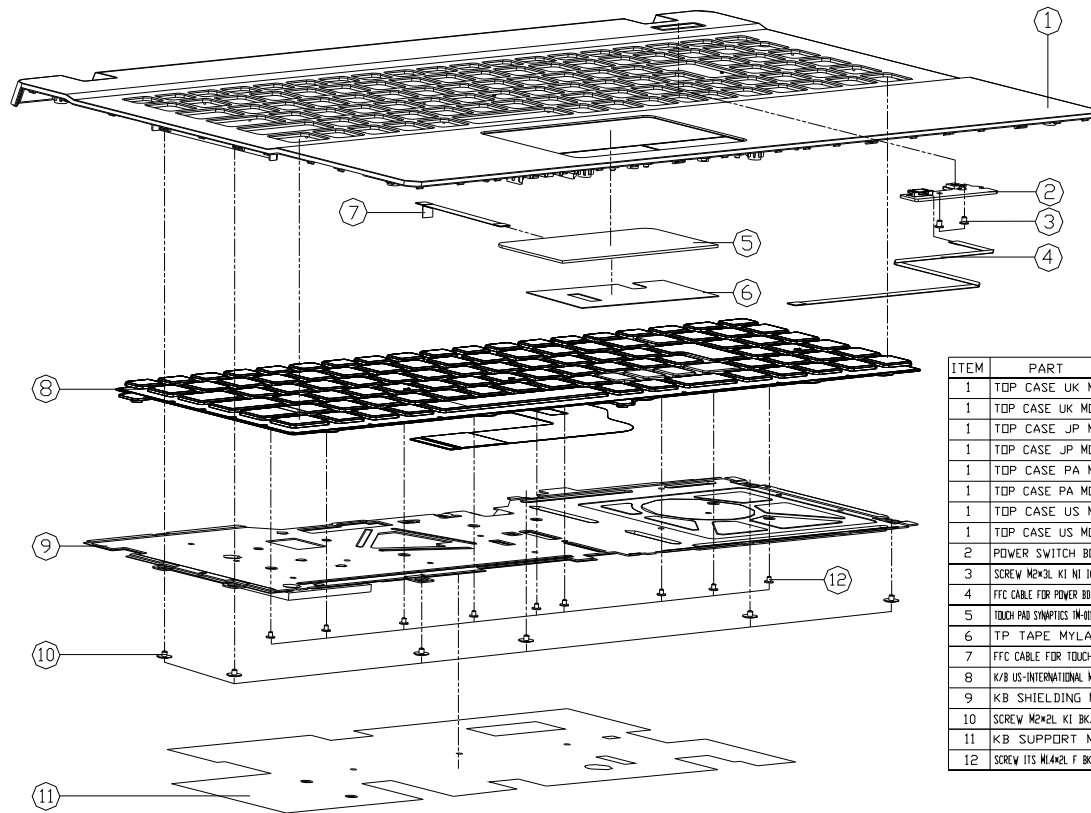
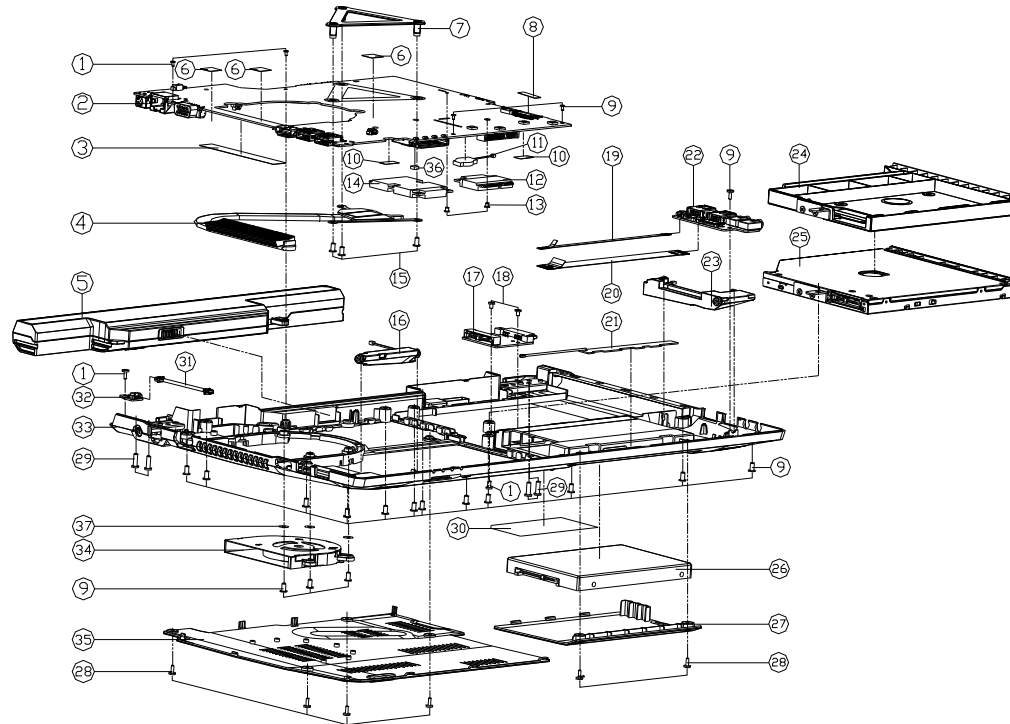

Figure A - 1
Top

ITEM	PART NAME	PART NO	REMARK
1	TOP CASE UK MODULE W550EU	6-39-W5502-021	
1	TOP CASE UK MODULE W550EU-C	6-39-W5502-021-C	
1	TOP CASE JP MODULE W550EU	6-39-W5502-041	
1	TOP CASE JP MODULE W550EU-C	6-39-W5502-041-C	
1	TOP CASE PA MODULE W550EU	6-39-W5502-011	
1	TOP CASE PA MODULE W550EU-C	6-39-W5502-011-C	
1	TOP CASE US MODULE W550EU	6-39-W5502-031	
1	TOP CASE US MODULE W550EU-C	6-39-W5502-031-C	
2	POWER SWITCH BOARD V2.0 W540EU	6-77-W540S-D02	
3	SCREW M2x3L KI NI ICT NY (D0=04.5,D1=04)	6-35-B1120-3RE	
4	FFC CABLE FOR POWER BD TO W/B 4PIN (HS) W550EU	6-43-W5500-011	
5	TOUCH PAD SYNAPTICS IN-0166-103 MULTI-GESTURE C4800	6-49-C4802-010	
6	TP TAPE MYLAR PET W540EU	6-40-W5401-010	
7	FFC CABLE FOR TOUCH PAD 6PIN(HS) W550EU	6-43-W5502-010	
8	K/B US-INTERNATIONAL WP-1209304-430V W550EU	6-80-W5501-011-1	
9	KB SHIELDING MODULE W550EU	6-33-W5502-101	
10	SCREW M2x2L KI BK/Z ICT NY (06,T=0.5)	6-35-B6120-2RC	
11	K/B SUPPORT MYLAR W550EU	6-40-W5502-020	
12	SCREW ITS M4x2L F BK/Z TAP (D0=04.5,D1=0.45)	6-35-26714-2R0	

Bottom

Figure A - 2
Bottom



ITEM	PART NAME	PART NO	REMARK
1	SCREW M2*4L KI BZ ICT NY	6-35-86120-4RA	
2	MAIN BOARD V23 (V30, V10, V10) W/IO W/SSU	6-77-W5500-002	
2	MAIN BOARD V23 (V30, V10, V10) W/IO W/SSU	6-77-W5500-002-1	
2	MAIN BOARD V23 (V30, V10, V10) W/IO W/SSU	6-77-W5500-002-2	
2	MAIN BOARD V23 (V30, V10, V10) W/IO W/SSU	6-77-W5500-002-3	
3	W/LR FOR FAN (OPTIONAL) P/100 400 W/SSU	6-40-W5405-010	
4	CPU HEATSINK MODULE (AL FIN) W/SSU	6-31-W540N-101	
5	TOP CASE (OPTIONAL) P/100 400 W/SSU	6-87-W5405-4271	(OPTION)
5	TOP CASE (OPTIONAL) P/100 400 W/SSU	6-87-W5405-4441	(OPTION)
5	TOP CASE (OPTIONAL) P/100 400 W/SSU	6-87-W5405-4442	(OPTION)
6	W/LR (OPTIONAL) BLACK (OPTIONAL) P/100 400 W/SSU	6-40-W5405-010	
7	CPU SUPPORTER FOR HEATSINK (OPTIONAL) P/100 400 W/SSU	6-32-W1505-011	
8	TOP CASE W/LR (OPTIONAL) P/100 400 W/SSU	6-40-PI802-030	
9	SCREW M2*5*SL KI BK/2 ICT NY	6-35-86125-5RA	
10	W/LR (OPTIONAL) P/100 400 W/SSU	6-40-PI803-020	
11	W/LR (OPTIONAL) P/100 400 W/SSU	6-23-22015-TC0	
12	W/LR (OPTIONAL) P/100 400 W/SSU	6-88-W345F-9400	(OPTION)
12	W/LR (OPTIONAL) P/100 400 W/SSU	6-88-W345F-0700	(OPTION)
12	W/LR (OPTIONAL) P/100 400 W/SSU	6-88-W5102-9400	(OPTION)
12	W/LR (OPTIONAL) P/100 400 W/SSU	6-88-W2940-7000	(OPTION)
12	W/LR (OPTIONAL) P/100 400 W/SSU	6-88-PI10F-4200	(OPTION)
12	W/LR (OPTIONAL) P/100 400 W/SSU	6-88-PI10F-4200	(OPTION)
13	SCREW NICH KI NI ICT NY (OPTIONAL) P/100 400 W/SSU	6-35-81120-3RE	(OPTION)
14	W/LR (OPTIONAL) P/100 400 W/SSU	6-85-D1410-200	
15	SCREW M2*5*SL F NI ICT NY	6-35-21125-4R0	
16	W/LR (OPTIONAL) P/100 400 W/SSU	6-23-5W540-011	
17	BRIDGE (OPTIONAL) P/100 400 W/SSU	6-77-W5567-001	
18	SCREW M2*3L KI NI ICT NY	6-35-81120-3RA	
19	W/LR (OPTIONAL) P/100 400 W/SSU	6-43-W5500-031	
20	W/LR (OPTIONAL) P/100 400 W/SSU	6-43-W5500-021	
21	W/LR (OPTIONAL) P/100 400 W/SSU	6-23-7450-030	
22	AUDIO BOARD V10 W/SSU	6-77-W5500-101	
23	W/LR (OPTIONAL) P/100 400 W/SSU	6-23-5W540-0R1	
24	DUMMY (OPTIONAL) P/100 400 W/SSU	6-79-W5500-010	(OPTION)
25	SATA (OPTIONAL) P/100 400 W/SSU	6-79-W5500-000	(OPTION)
25	W/D (OPTIONAL) P/100 400 W/SSU	6-79-W5500-000	(OPTION)
26	HDD (OPTIONAL) P/100 400 W/SSU	6-79-C4000J-000	
26	W/HDD (OPTIONAL) P/100 400 W/SSU	6-79-CH2000J-000	
27	HDD COVER (PC-ABS) W/SSU	6-42-W550J-010	
27	HDD COVER (PC-ABS) W/SSU	6-42-W550J-010-C	
28	SCREW NICH KI NI ICT NY	6-35-86120-5R0	
29	SCREW M2*5*SL KI BK/2 NY ICT	6-35-86125-6R0	
30	PRODUCT LABEL FOR W/SSU	6-49-W5500-010	
31	W/LR (OPTIONAL) P/100 400 W/SSU	6-43-W5503-011	
32	LID SWITCH BOARD V10 W/SSU	6-77-W5565-001	
33	BOTTOM CASE MODULE W/SSU	6-39-W5503-011	
33	BOTTOM CASE MODULE W/SSU	6-39-W5503-011-C	
34	FAN MODULE W/SSU	6-31-W2945-100	
35	CPU COVER MODULE W/SSU	6-42-W5500-101	
36	CASET (OPTIONAL) P/100 400 W/SSU	6-47-0019A-608	
37	W/LR FOR BOTTOM COVER (OPTIONAL) P/100 400 W/SSU	6-40-W5503-010	

COMBO

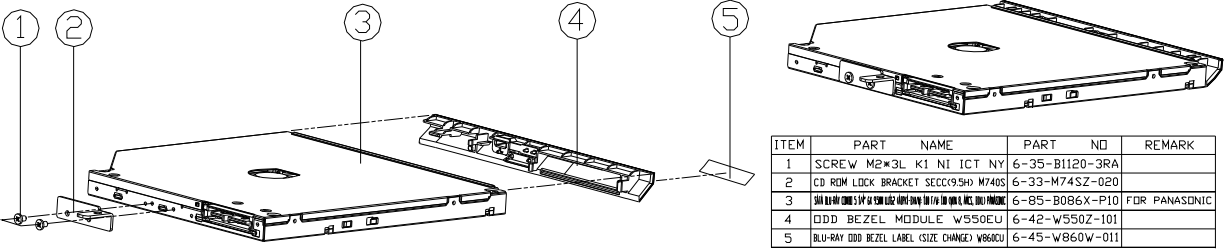

ITEM	PART NAME	PART NO	REMARK
1	SCREW M2*3L K1 NI ICT NY	6-35-B1120-3RA	
2	CD ROM LOCK BRACKET SECC(9.5H) M740S	6-33-M74SZ-020	
3	ODD BEZEL MODULE W550EU	6-85-B086X-P10	FDR PANASONIC
4	ODD BEZEL MODULE W550EU	6-42-W550Z-101	
5	BLU-RAY ODD BEZEL LABEL (SIZE CHANGED) W860U	6-45-W860W-011	

Figure A - 3
COMBO

DVD DUAL

Figure A - 4
DVD DUAL

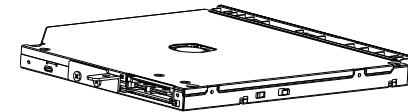
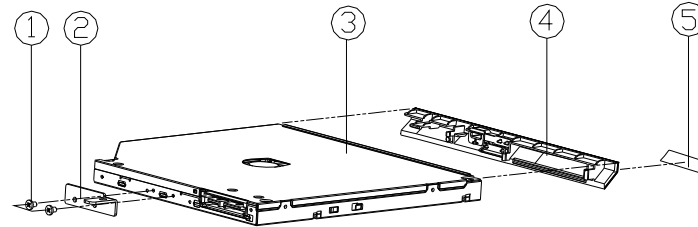

ITEM	PART NAME	PART NO	REMARK
1	SCREW M2*3L K1 NI ICT NY	6-35-B1120-3RA	
2	CD ROM LOCK BRACKET SECC(95H) M740S	6-33-M74SZ-020	
3	SUPER MULTI 5 LAYER DVD-RW DISC (16X) (120MB) (1.28UM) (1.28UM) (1.28UM)	6-85-A088X-P03	FOR PANASONIC
3	SUPER MULTI 5 LAYER DVD-RW DISC (16X) (120MB) (1.28UM) (1.28UM) (1.28UM)	6-85-A088X-L00	FOR PLDS
3	SUPER MULTI 5 LAYER DVD-RW DISC (16X) (120MB) (1.28UM) (1.28UM) (1.28UM)	6-85-A088X-T04	FOR TSST
4	DVD BEZEL MODULE W550EU	6-42-W550Z-101	
5	SUPER MULTI DVD BEZEL LABEL (SIZE CHANGE)	6-45-W8600-011	

Dummy ODD

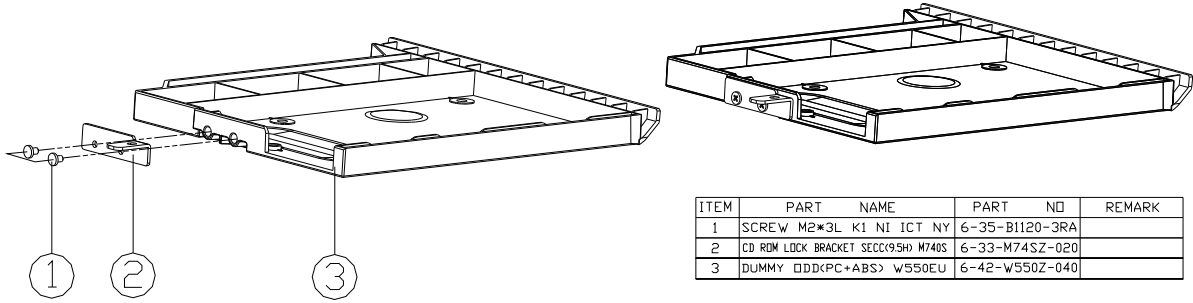

ITEM	PART NAME	PART NO	REMARK
1	SCREW M2*3L K1 NI ICT NY	6-35-B1120-3RA	
2	CD ROM LOCK BRACKET SECC(9.5H) M740S	6-33-M74SZ-020	
3	DUMMY ODD(PC+ABS) W550EU	6-42-W550Z-040	

Figure A - 5
Dummy ODD

LCD

Figure A - 6
LCD

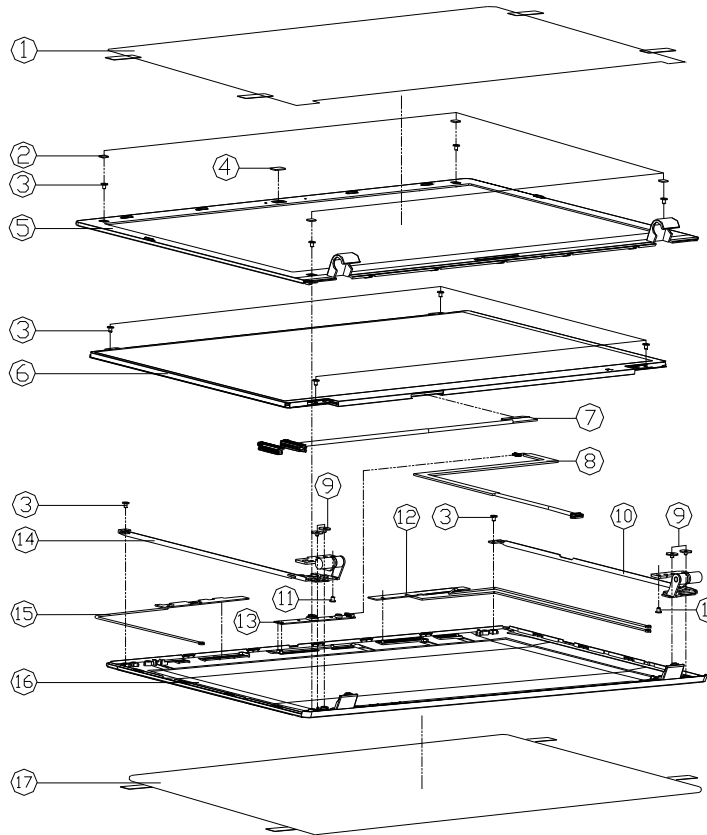

ITEM	PART NAME	PART NO	REMARK
1	LCD FRONT COVER PROTECTION FILM 0825-28053 ES200	6-40-E5101-030	
2	FRONT COVER SCREW RUBBER W540EU	6-47-W5401-011	
3	SCREW M2xL KI NI ICT NY (30) (#45,01#04)	6-35-B1120-3RE	
4	CCD LENS PMMA W540EU	6-42-W5401-010	OPTION
4	W/O CCD LENS PMMA W540EU	6-42-W5401-020	OPTION
5	LCD FRONT COVER MODULE W550EU	6-39-W5501-011	
6	LCD 15.6" HD LG LP156WH4-SLBS C3 400 LED	6-50-LB234-L01	OPTION
6	LCD 15.6" HD LG LP156WH4-SLBS C3 400 LED	6-50-LB138-L00	OPTION
6	LCD 15.6" HD LG LP156WH4-SLBS C3 400 LED	6-50-LB138-L01	OPTION
6	LCD 15.6" HD LG LP156WH4-SLBS C3 400 LED	6-50-LB138-L00	OPTION
7	WIRE CABLE FOR LCD (W550EU) 15.6" HD LG LP156WH4-SLBS C3 400 LED	6-43-W5501-010-C	
7	WIRE CABLE FOR LCD (W550EU) 15.6" HD LG LP156WH4-SLBS C3 400 LED	6-43-W5501-020-C	
8	WIRE CABLE FOR CCD AP (490NM GEL) W550EU	6-43-W550T-010	
9	SCREW M2xL KI BR/Z ICT NY (#40,1#04)	6-35-B6120-2RE	
10	LCD HINGE R W550EU	6-33-W5501-0R1	
11	SCREW M2xL KI BR/Z ICT NY (#40,1#04)	6-35-B6125-5R0	
12	SCREW M2xL KI BR/Z ICT NY (#40,1#04)	6-23-7W550-010	
13	LCD 15.6" HD LG LP156WH4-SLBS C3 400 LED	6-88-W540C-4901	OPTION
13	LCD 15.6" HD LG LP156WH4-SLBS C3 400 LED	6-88-W540C-5101	OPTION
14	LCD HINGE L W550EU	6-33-W5501-0L1	
15	LCD 15.6" HD LG LP156WH4-SLBS C3 400 LED	6-23-7W550-020	OPTION
16	LCD BACK COVER MODULE W550EU	6-39-W5501-021	
16	LCD BACK COVER MODULE W550EU-C	6-39-W5501-021-C	
17	LCD BACK COVER PROTECTION FILM 0825-28053 ES200	6-40-E5101-041	

Appendix B: Schematic Diagrams

This appendix has circuit diagrams of the *W550EU* notebook's PCB's. The following table indicates where to find the appropriate schematic diagram.

Diagram - Page	Diagram - Page	Diagram - Page
<i>System Block Diagram - Page B - 2</i>	<i>PCH 4/9- LVDS, DDI, CRT - Page B - 16</i>	<i>5VS, 3VS, 1.5VS CPU - Page B - 30</i>
<i>Processor 1/7-DMI, FDI, PEG - Page B - 3</i>	<i>PCH 5/9- PCI, USB, RSVD - Page B - 17</i>	<i>VDD3, VDD5 - Page B - 31</i>
<i>Processor 2/7- CLK, MISC - Page B - 4</i>	<i>PCH 6/9- GPIO, CPU - Page B - 18</i>	<i>Power 0.85VS, 1.8VS - Page B - 32</i>
<i>Processor 3/7- (DDR3) - Page B - 5</i>	<i>PCH 7/9- PWR - Page B - 19</i>	<i>POWER 1.5V/1.05VS - Page B - 33</i>
<i>Processor 4/7- Power - Page B - 6</i>	<i>PCH 8/9 POWER - Page B - 20</i>	<i>POWER VCORE1 - Page B - 34</i>
<i>Processor 5/7- GFX PWR - Page B - 7</i>	<i>PCH 9/9- GND - Page B - 21</i>	<i>POWER VCORE2 - Page B - 35</i>
<i>Processor 6/7- GND - Page B - 8</i>	<i>WLAN, 3G, MSATA - Page B - 22</i>	<i>AC IN, CHARGER - Page B - 36</i>
<i>Processor 7/7- RSVD - Page B - 9</i>	<i>CCD, TPM, FAN, CLICK - Page B - 23</i>	<i>AUDIO BOARD - Page B - 37</i>
<i>DDR3 SO-DIMM_0 - Page B - 10</i>	<i>USB3.0, LID SWITCH - Page B - 24</i>	<i>AUDIO BOARD (W550EU) - Page B - 38</i>
<i>DDR3 SO-DIMM_1 - Page B - 11</i>	<i>Card Reader (RTL8411) - Page B - 25</i>	<i>LID SW BOARD (W550EU) - Page B - 39</i>
<i>PANEL, INVERTER, CRT - Page B - 12</i>	<i>SATA ODD, LED, USB CHARGE - Page B - 26</i>	<i>POWER SW BOARD - Page B - 40</i>
<i>PCH 1/9- RTC, HDA, SATA - Page B - 13</i>	<i>HDMI, RJ45 - Page B - 27</i>	<i>EXTERNAL ODD BOARD - Page B - 41</i>
<i>PCH 2/9- PCIE, SMBUS, CLK - Page B - 14</i>	<i>AUDIO CODEC VT1802P - Page B - 28</i>	<i>Power Diagram - Page B - 42</i>
<i>PCH 3/9- DMI, FDI, PWRGD - Page B - 15</i>	<i>KBC-ITE IT8518E - Page B - 29</i>	<i>Power On SEQ - Page B - 43</i>

Table B - 1
**SCHEMATIC
DIAGRAMS**



Version Note

The schematic diagrams in this chapter are based upon version 6-7P-W5406-001. If your mainboard (or other boards) are a later version, please check with the Service Center for updated diagrams (if required).

System Block Diagram

Sheet 1 of 42
System Block
Diagram

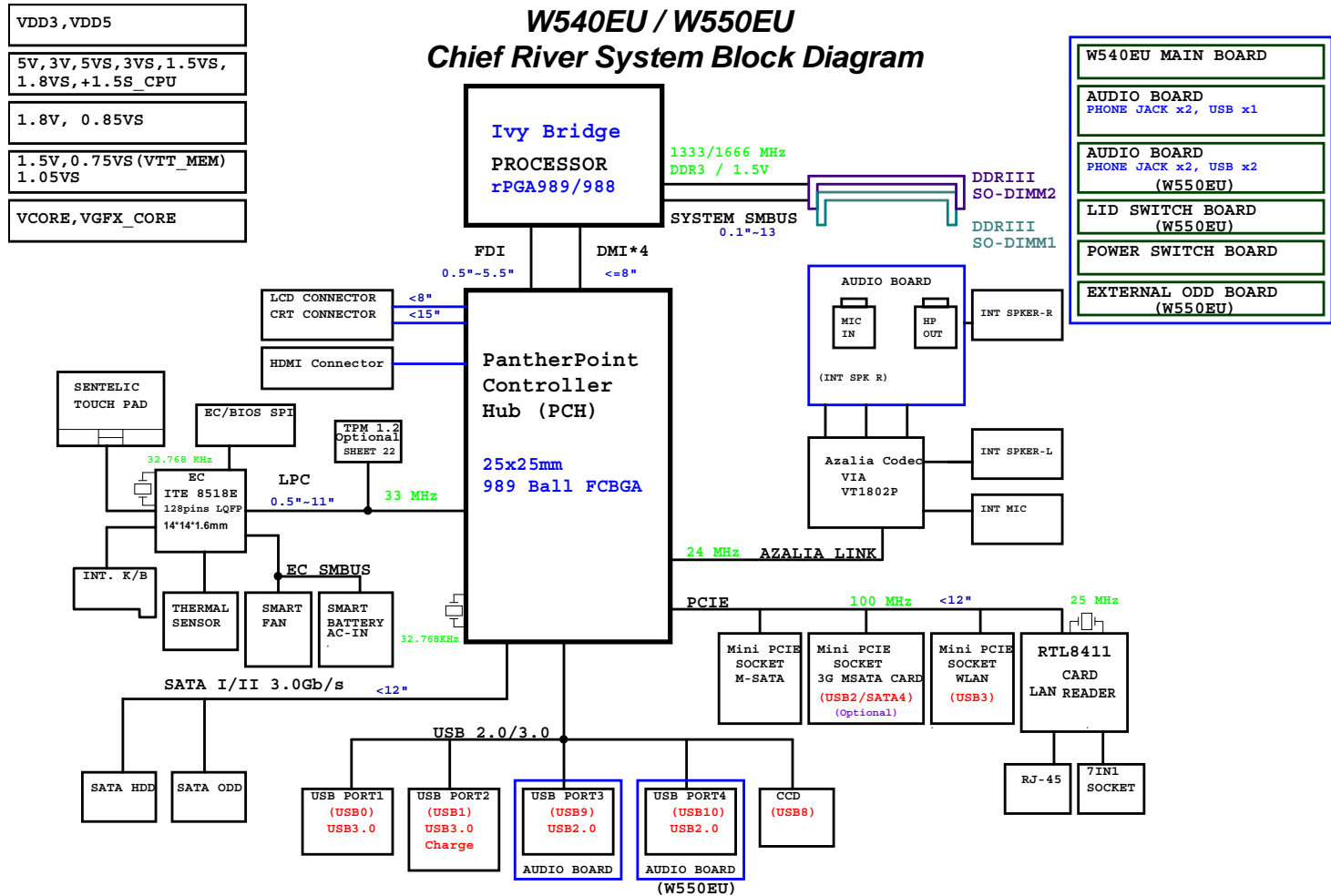

Processor 1/7-DMI, FDI, PEG

Ivy Bridge Processor 1/7 (DMI,PEG,FDI)

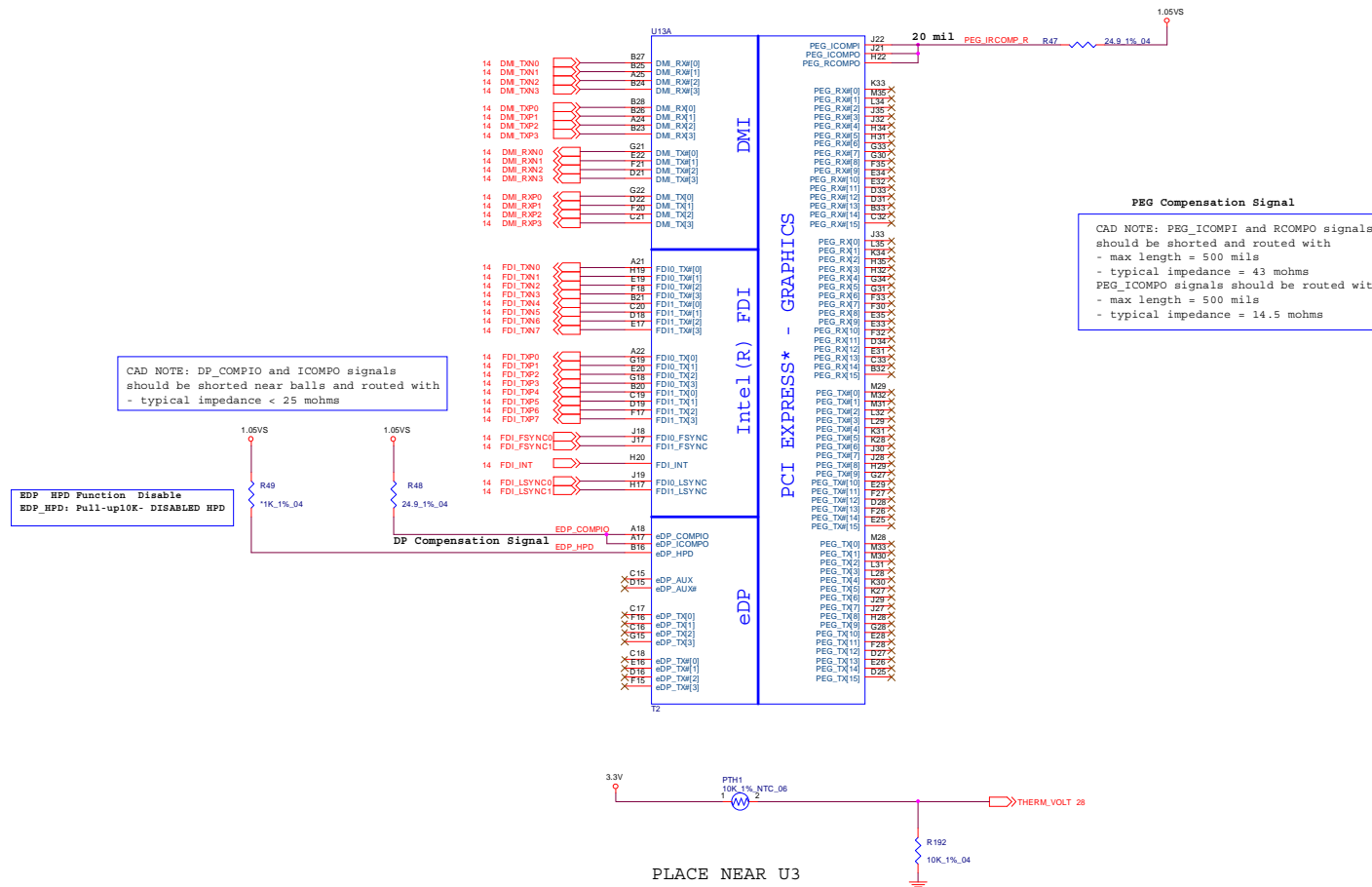

Sheet 2 of 42
Processor 1/7-DMI,
FDI, PEG

B.Schematic Diagrams

Processor 2/7- CLK, MISC

Sheet 3 of 42
Processor 2/7-CLK,
MISC

Ivy Bridge Processor 2/7 (CLK, MISC, JTAG)

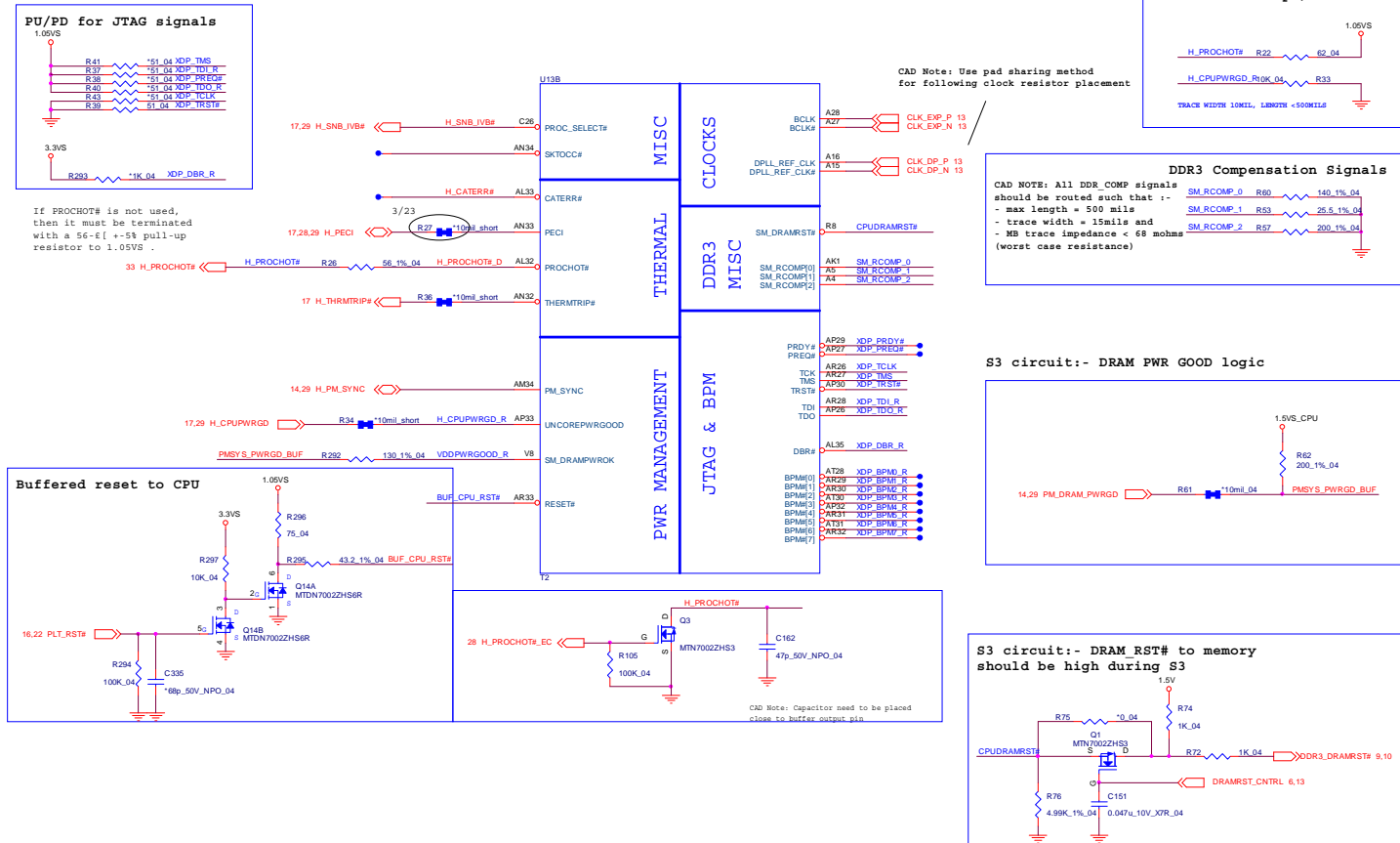

Processor 3/7- (DDR3)

Ivy Bridge Processor 3/7 (DDR3)

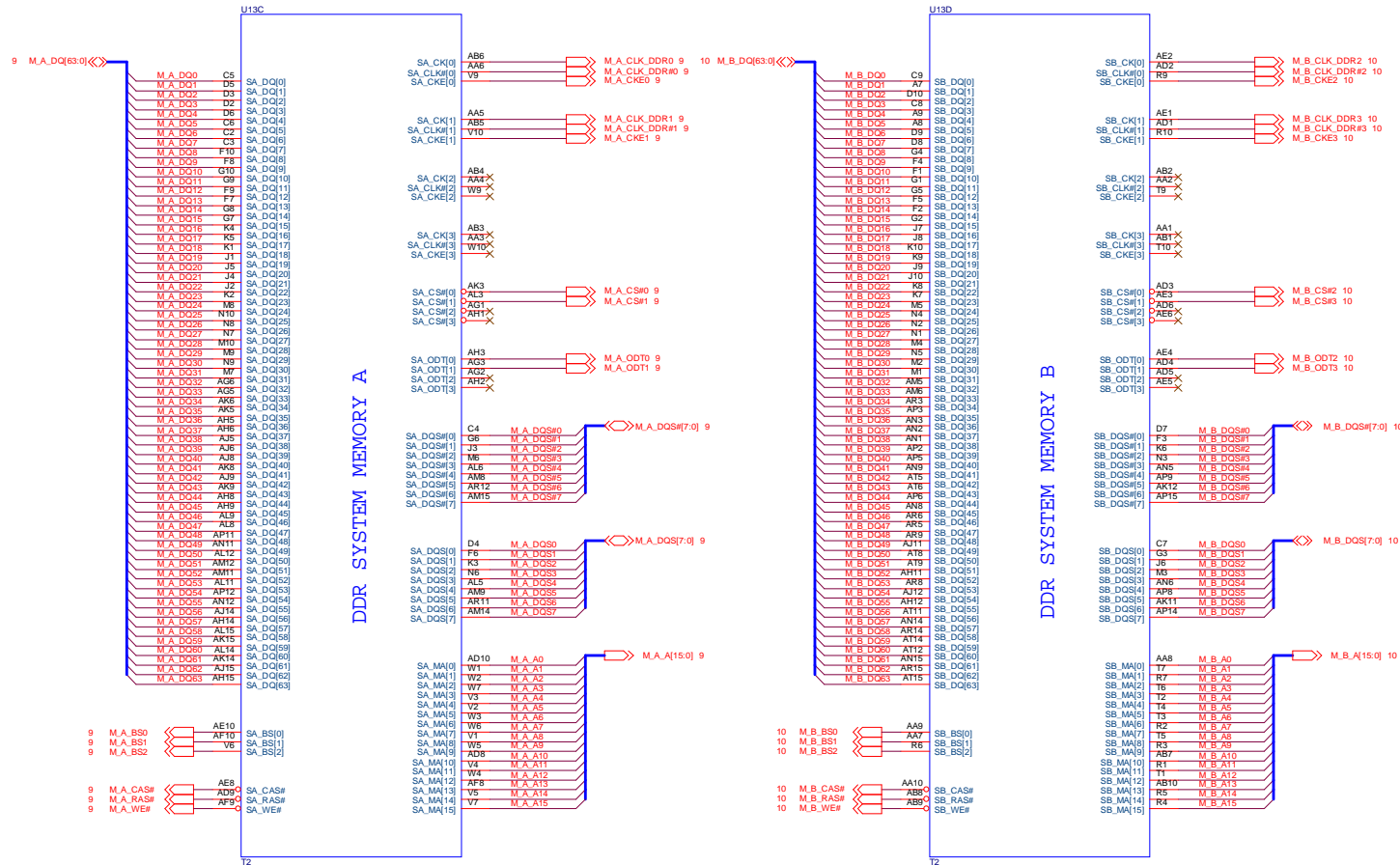

Sheet 4 of 42
Processor 3/7-
(DDR3)

B.Schematic Diagrams

Processor 6/7- GND

Ivy Bridge Processor 6/7 (GND)

Sheet 7 of 42
Processor 6/7- GND

CAD Note: 0 ohm resistor should be placed close to CPU

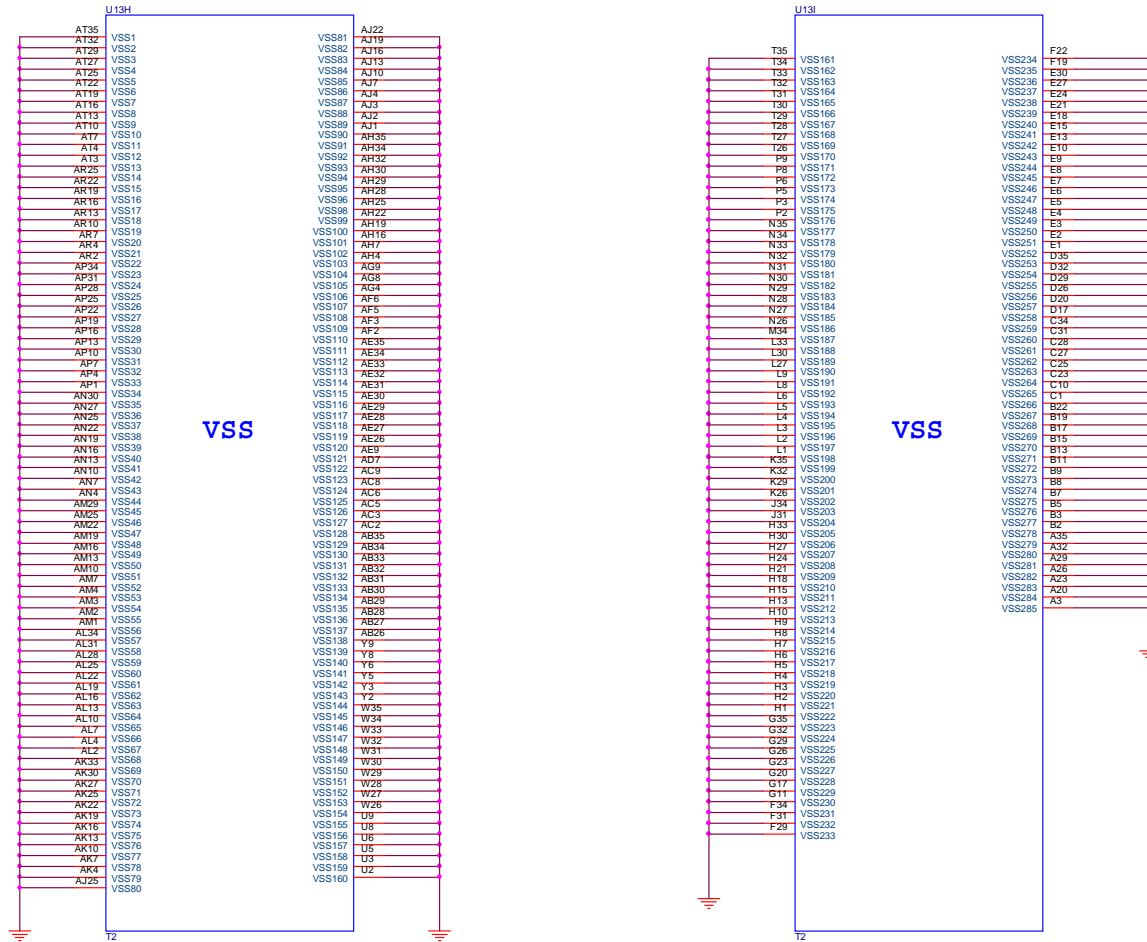

Processor 7/7- RSVD

Ivy Bridge Processor 7/7 (RESERVED)

CFG Straps for Processor

PEG Static Lane Reversal - CFG2 is for the 16x	
CFG2	1: (Default) Normal Operation; Lane # definition matches socket pin map definition 0: Lane Reversed

Display Port Presence Strap

CFG4	1: (Default) Disabled; No Physical Display Port attached to Embedded Display Port 0: Enabled; An external Display Port device is connected to the Embedded Display Port
------	--

PCIe Port Bifurcation Straps

CFG [6 : 5]	11: (Default) x16 - Device 1 functions 1 and 2 disabled 10: x8, x8 - Device 1 function 1 enabled ; function 2 disabled 01: Reserved - (Device 1 function 1 disabled ; function 2 enabled) 00: x8, x4, x4 - Device 1 functions 1 and 2 enabled
-------------	--

On CRB
H_SNB_IVB#_PWRCTRL = low, 1.0V
H_SNB_IVB#_PWRCTRL = high/NC, 1.05V

PEG DEFER TRAINING

CFG7	1: (Default) PEG Train immediately following xxRESETB de assertion 0: PEG Wait for BIOS for training
------	---

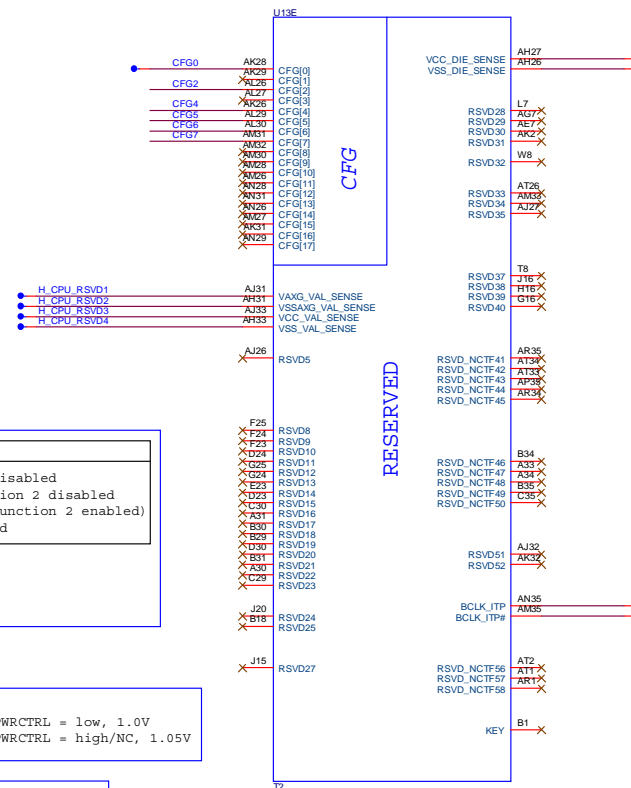

Sheet 8 of 42
Processor 7/7-
RSVD

B.Schematic Diagrams

DDR3 SO-DIMM_0

SO-DIMM A

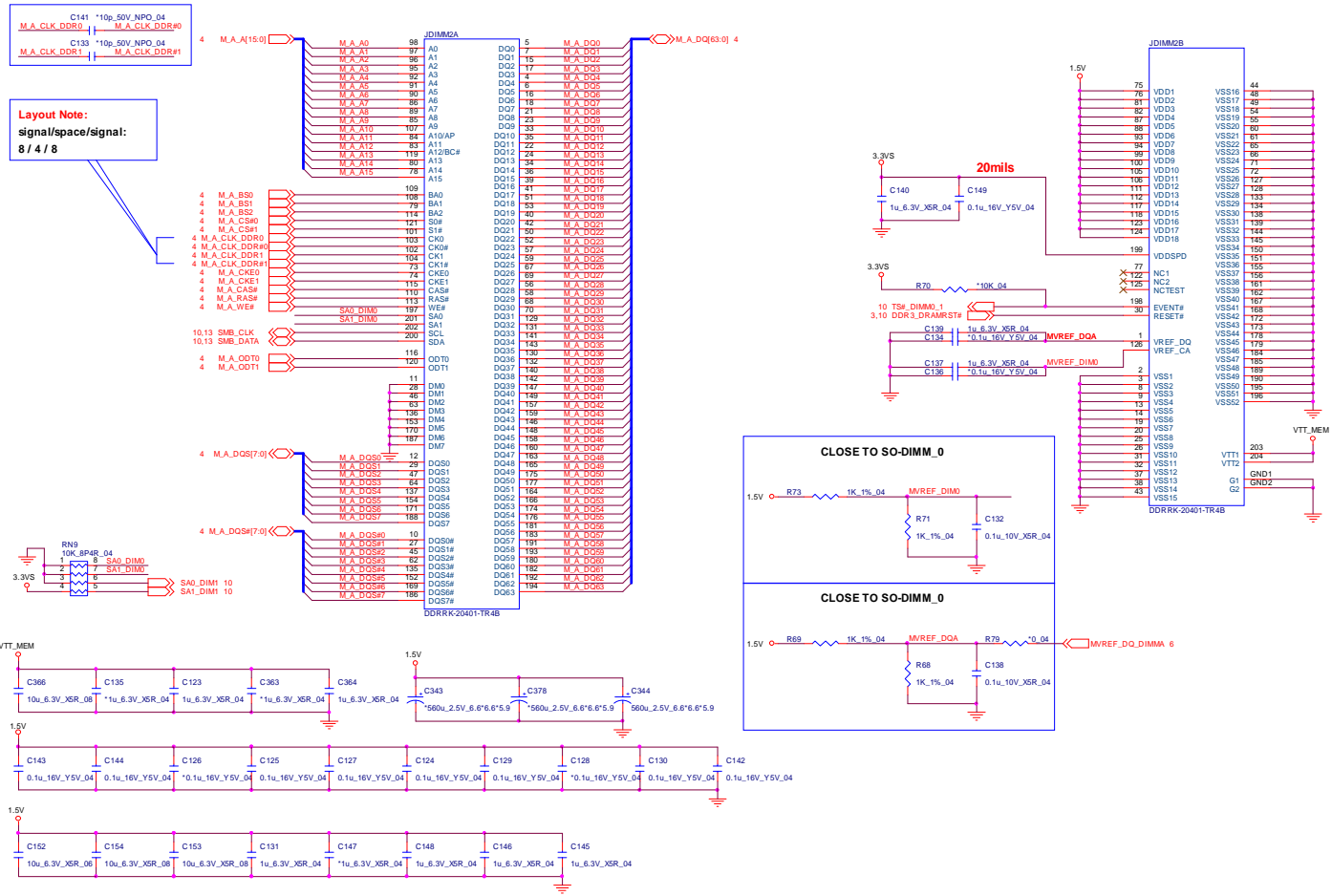

B.Schematic Diagrams

Sheet 9 of 42
DDR3 SO-DIMM_0

DDR3 SO-DIMM_1

SO-DIMM B

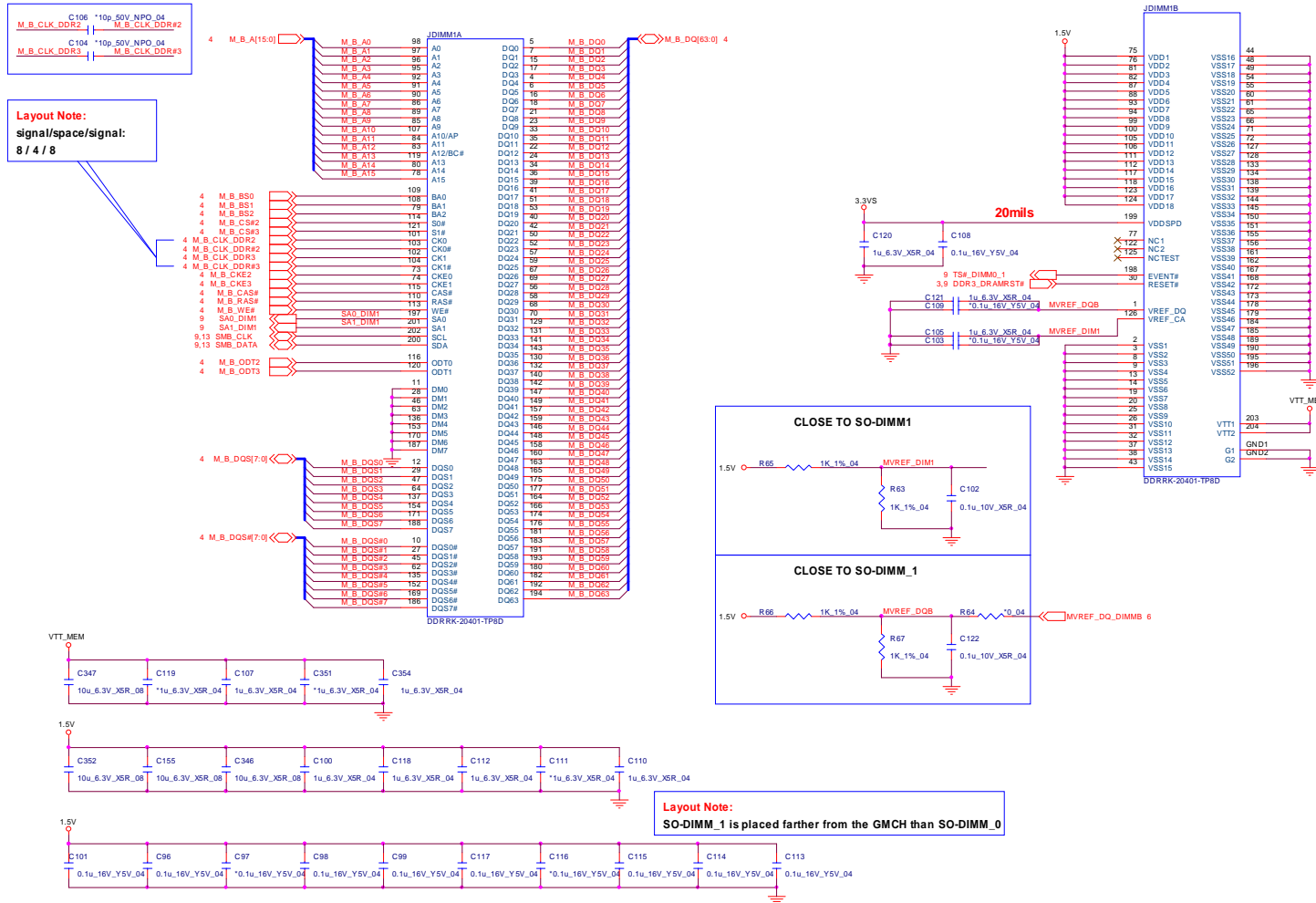

Sheet 10 of 42
DDR3 SO-DIMM_1

PCH 1/9- RTC, HDA, SATA

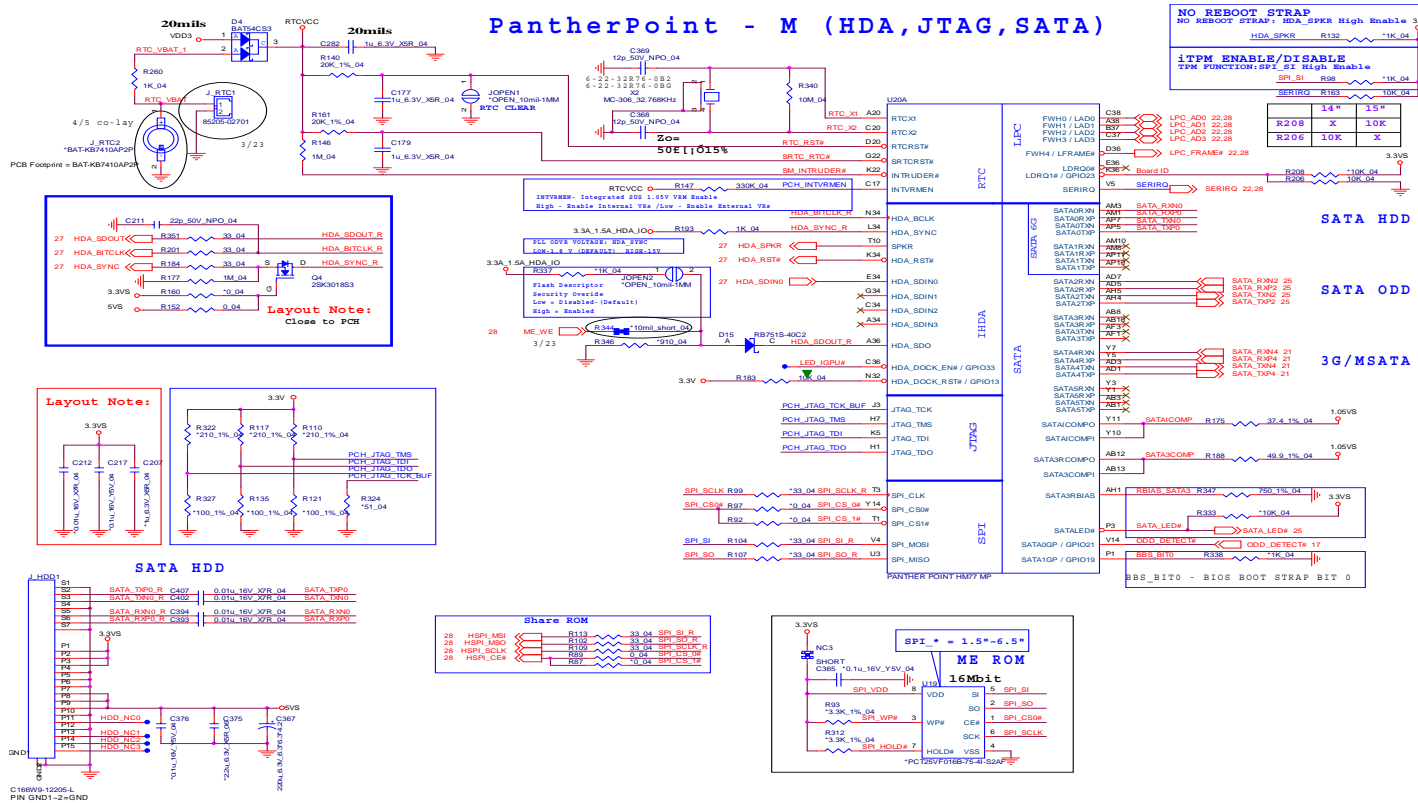

Sheet 12 of 42
 PCH 1/9- RTC, HDA,
 SATA

PCH 3/9- DMI, FDI, PWRGD

PantherPoint -M (DMI, FDI, GPIO)

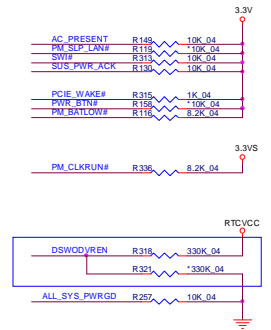
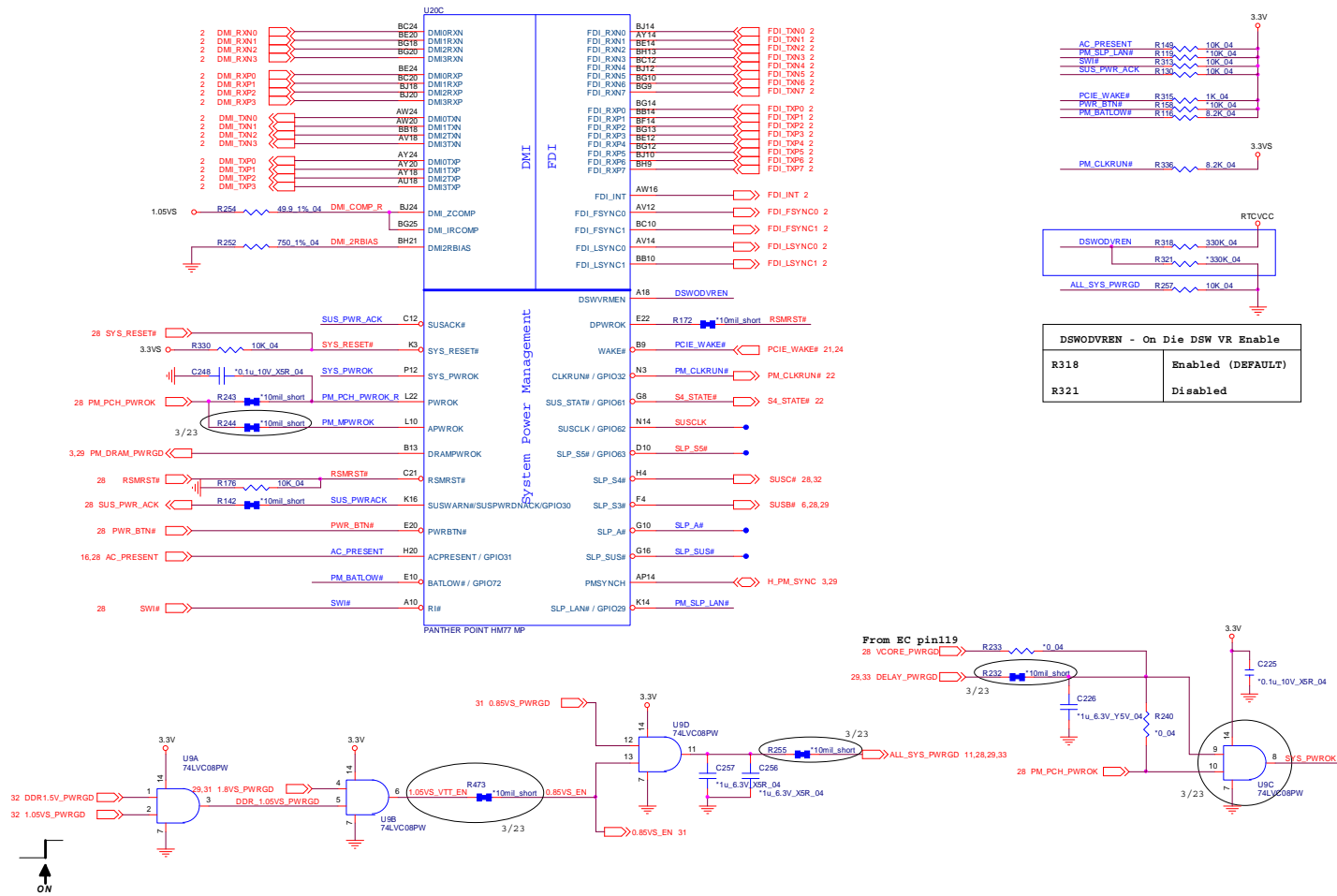

DSWODVREN - On Die DSW VR Enable	
R318	Enabled (DEFAULT)
R321	Disabled

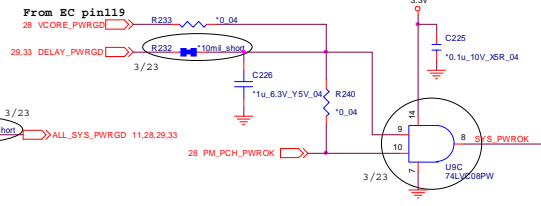

Sheet 14 of 42
PCH 3/9- DMI, FDI,
PWRGD

B.Schematic Diagrams

PCH 4/9- LVDS, DDI, CRT

Sheet 15 of 42
PCH 4/9- LVDS,
DDI, CRT

PantherPoint -M (LVDS,DDI)

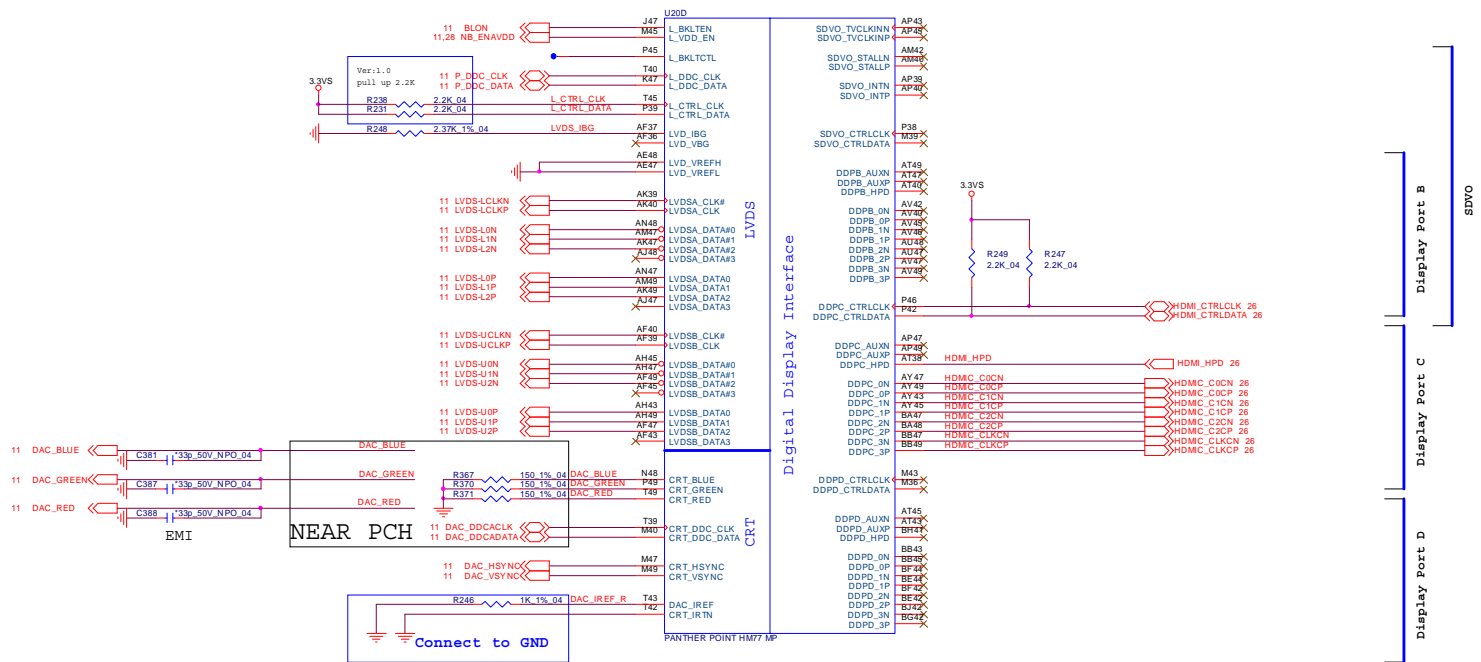

PCH 6/9- GPIO, CPU

Sheet 17 of 42
PCH 6/9- GPIO, CPU

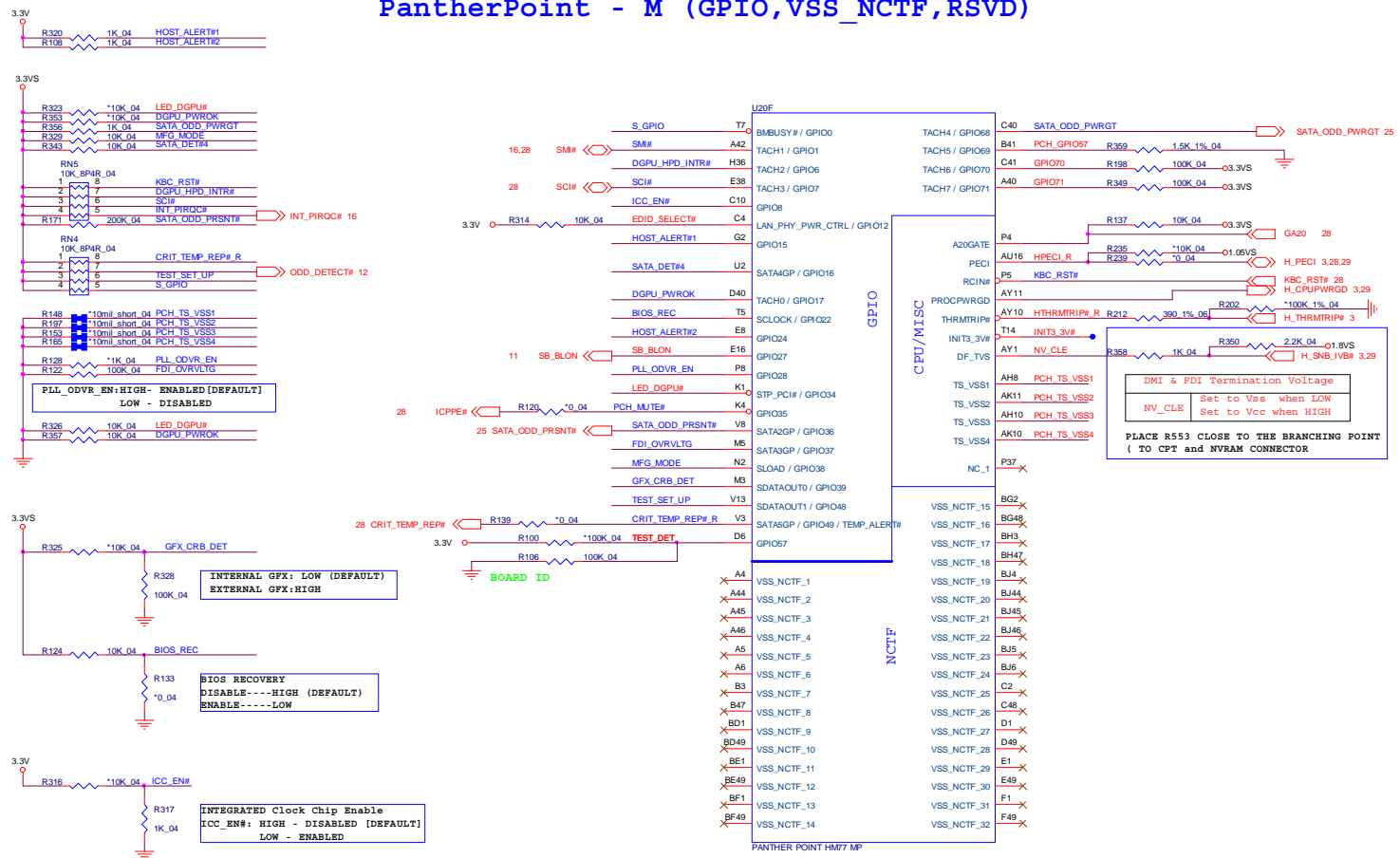

PCH 9/9- GND

PantherPoint -M (GND)

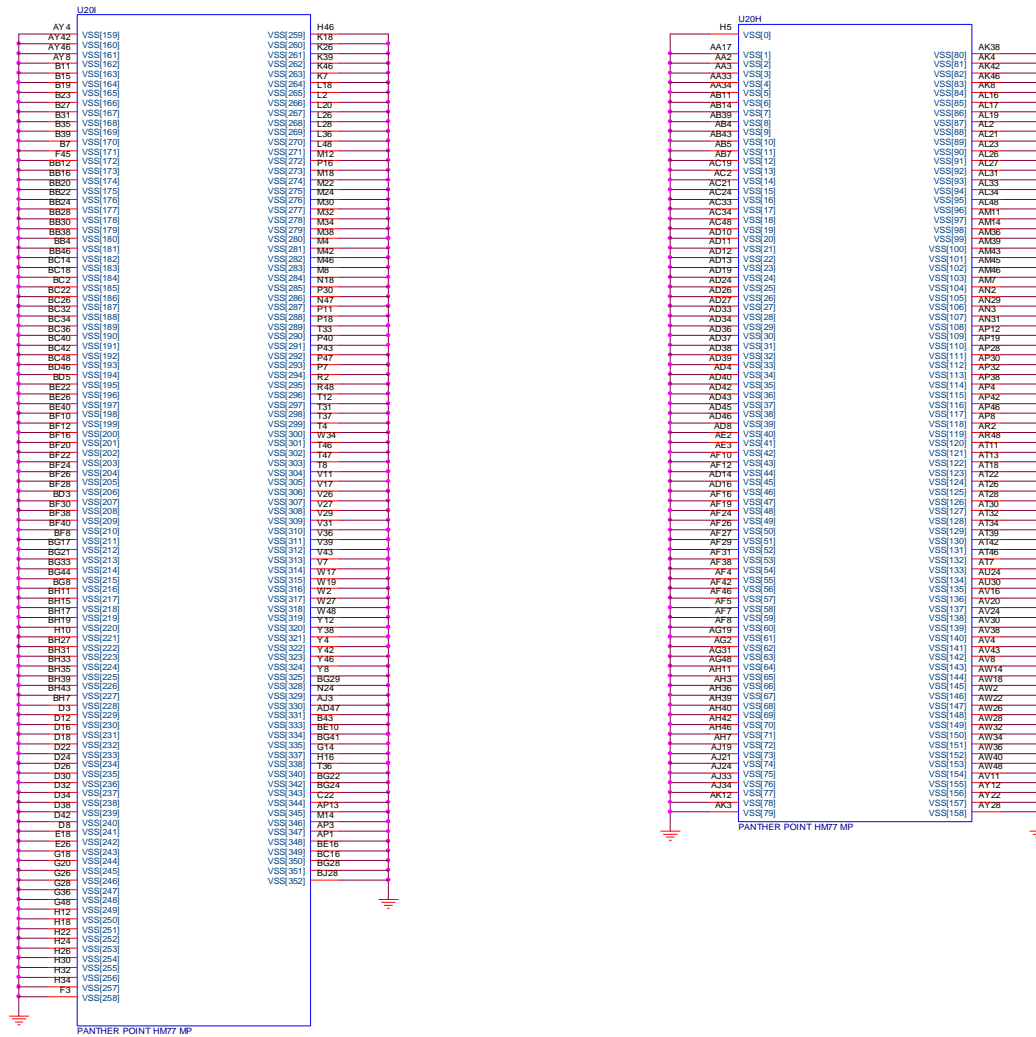

Voltage Rail	Voltage	80 Iccmax Current (A)
V_CPU_IO	1.05	1 (mA)
V5RREF	5	1 (mA)
V5RREF_Sus	5	1 (mA)
Vcc3_3	3.3	0.266
VccADAC3	1.05	1 (mA)
VccADPLLA	1.05	0.08
VccADPLL	1.05	0.08
VccCore	1.05	1.3
VccDMI	1.1	0.042
VccIO	1.05	2.925
VccASW	1.05	1.01
VccSPI	3.3	0.020
VccDSW3_3	3.3	2 (mA)
VccDFP2RM	1.8	0.19
VccSus3_3	3.3	0.097
VccSusEDA	3.3	1 (mA)
VccVRM	1.5	0.16
VccCLKDMI	1.05	0.02
VccSBC	1.05	0.095
VccDFPCLKN	1.05	0.055
VccALVDS	3.3	1 (mA)
VccTX_LVDS	1.8	0.05

Sheet 20 of 42
PCH 9/9- GND

CCD, TPM, FAN, CLICK

FOR POWER SW BOARD

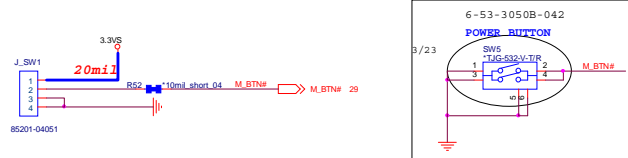

CLICK CONN

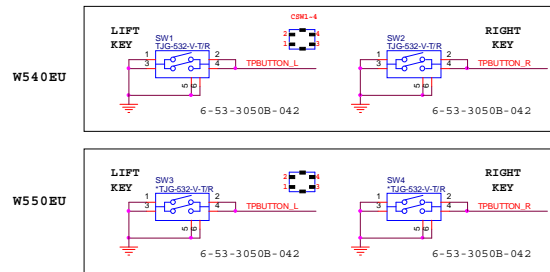
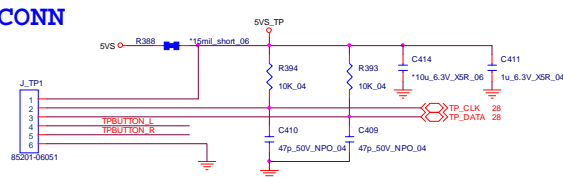

CCD + Internal MIC

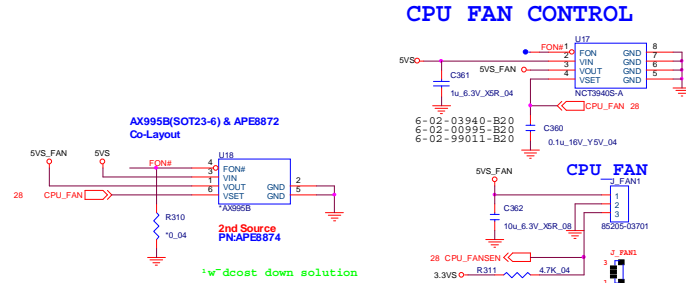
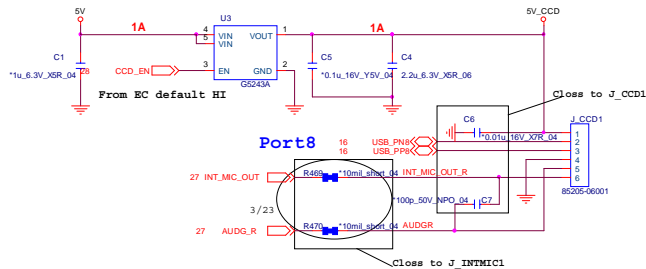

TPM 1.2

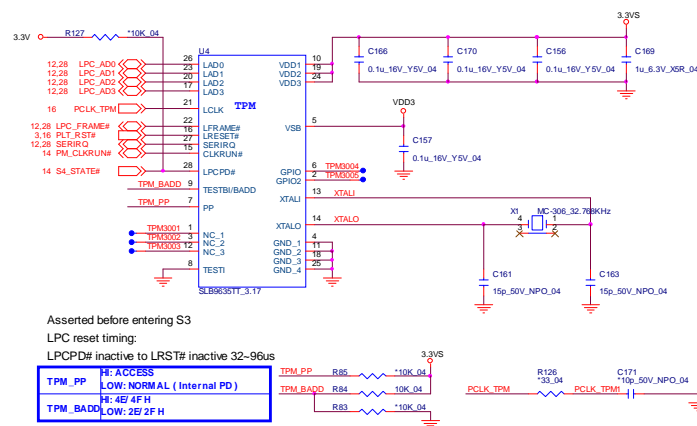

Sheet 22 of 42
CCD, TPM, FAN,
CLICK

USB3.0, LID SWITCH

Sheet 23 of 42
USB3.0, LID SWITCH

USB 3.0

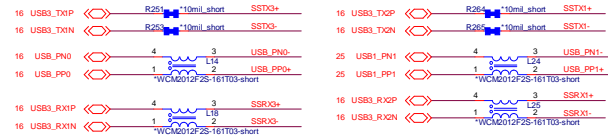
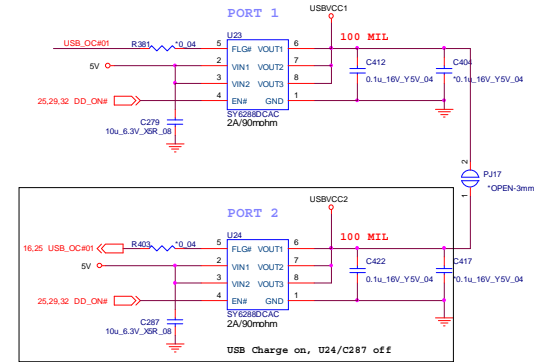
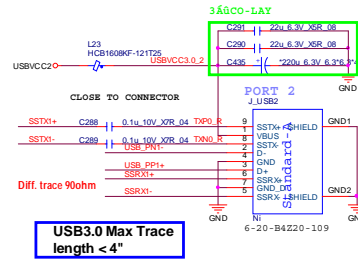
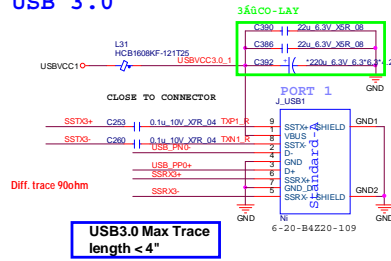

- USB3.0 Layout Guidelines:**
1. USB3.0 Differential trace impedance: 90ohm
 2. Differential pairs The USB3.0 the total trace skew less than 5 mils.
 3. IC pad to USB Connector total length < 4" (Max)
 4. USB3.0 Capacitor 0.1u_10V_X7R_04 Close to Connector.
 5. PCIe Differential impedance 85 ohm.
 6. PCIe For transmitter and receiver the total trace length: 1" (Min)--6" (Max).
 7. PCIe Number of vias 4via hole (Max).
 8. PCIe clock Differential impedance 100 ohm.
 9. PCIe Differential pairs and pairs spacing 20mils, with Other trace spacing 25mils.
 10. Power Trace width=20mils, Spacing=80 mils.

LID SWITCH IC

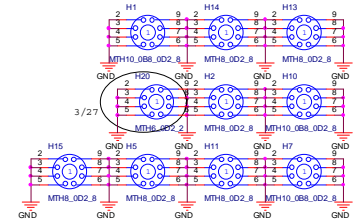
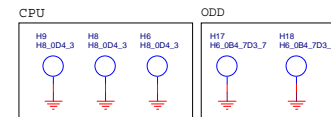
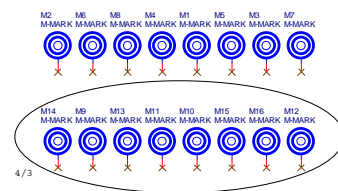
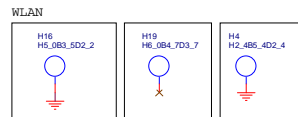
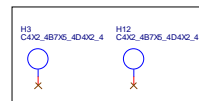
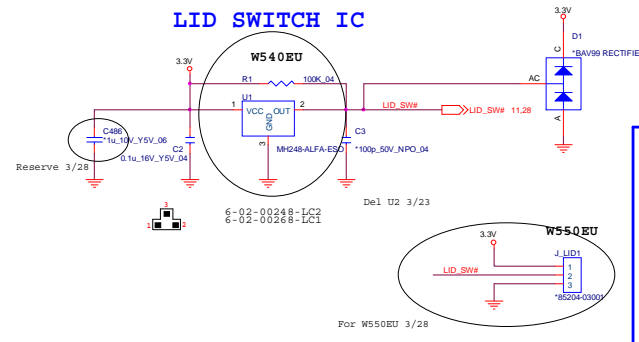

Card Reader (RTL8411)

B.Schematic Diagrams

Sheet 24 of 42
Card Reader
(RTL8411)

RTL8411

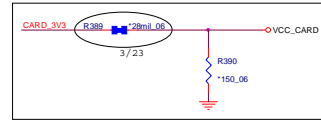

LAN VDD33 Rising Time; G

lms ~ 100ms

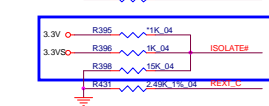
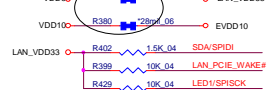

Remind that R331 using the main power (80 power)

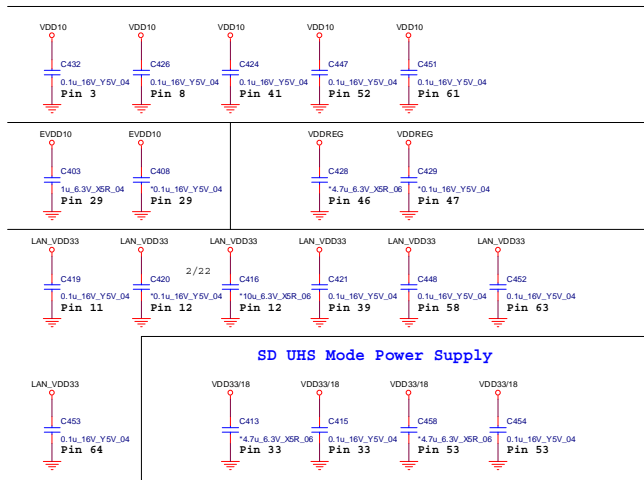

SD UHS Mode Power Supply

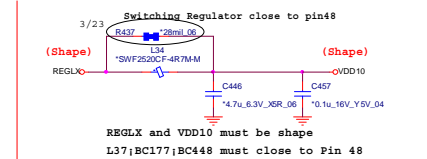
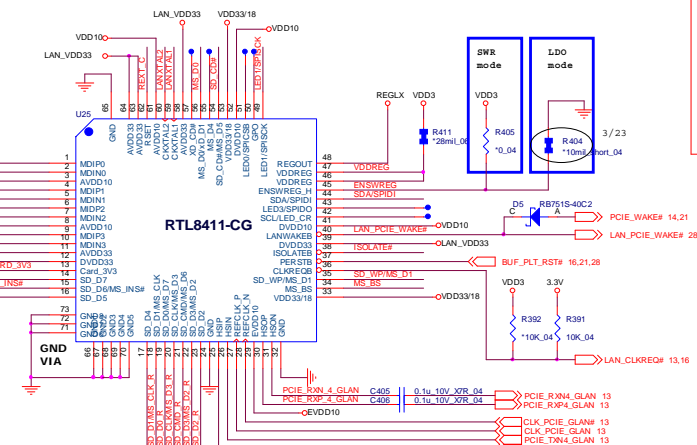
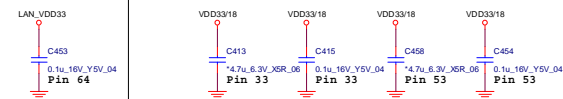

REGLX and VDD10 must be shape
L37;BC177;BC448 must close to Pin 48

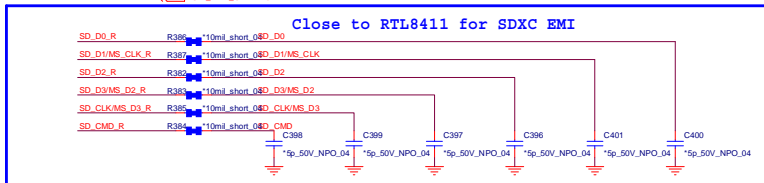
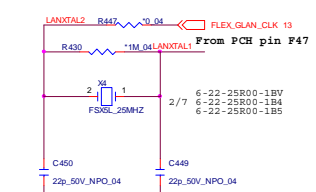

Close to RTL8411 for SDXC EMI

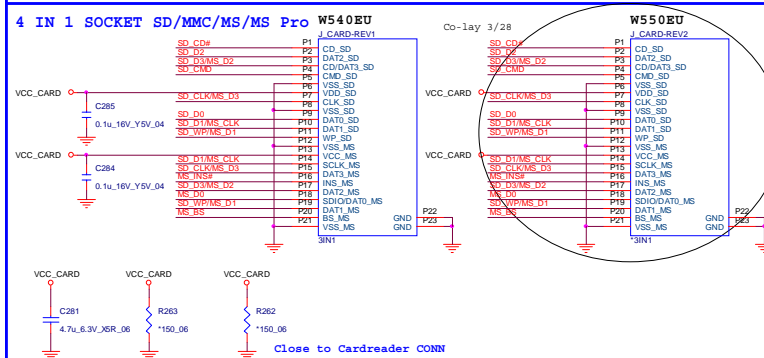

Close to Cardreader CONN

SATA ODD, LED, USB CHARGE

Sheet 25 of 42
SATA ODD, LED,
USB CHARGE

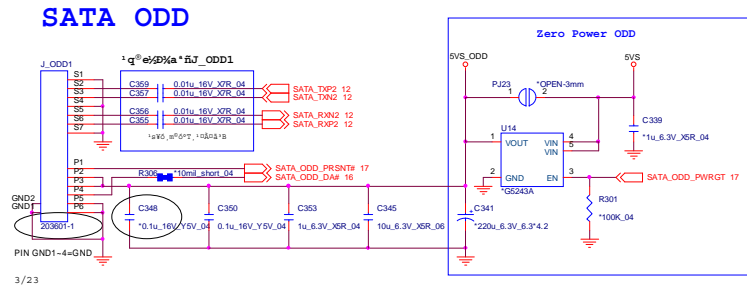

BAT LED POWER ON LED

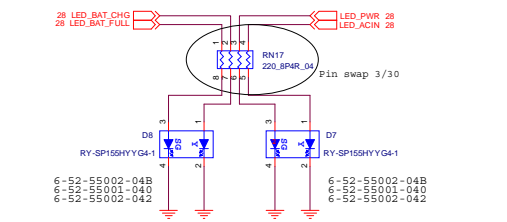

HDD LED WLAN/BT LED

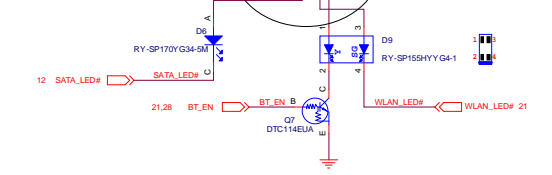

USB Charge PORT

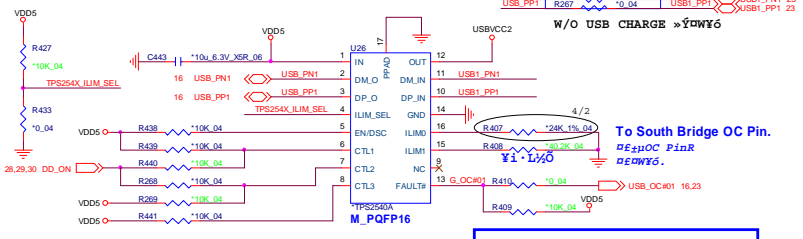

		(DD_ON) CTL1	(VDD5) CTL2	(VDD5) CTL3
Mode 1	Power off & Discharge	0	0	0
Mode 2	Power off & Charge	0	1	1
Mode 3	Power off & Charge	1	0	1
Mode 4	Power on & Charge	1	1	1

ILIM_SEL
(FOR TPS2543/TPS2540 |>ME|P)
ILIM_SEL=HI , FOR TPS2543
ILIM_SEL=LOW, FOR TPS2540A

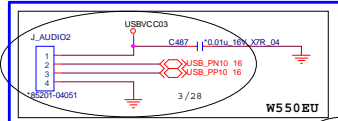

FOR AUDIO BOARD

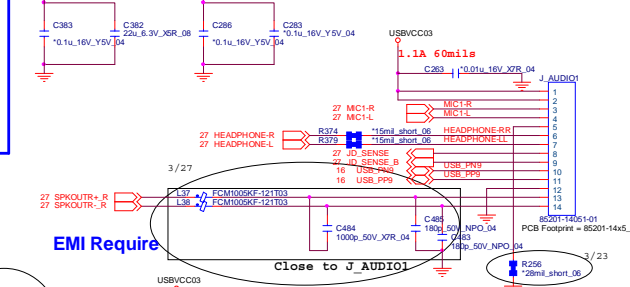

EMI Require

AUDIO CODEC VT1802P

CODEC (ALC269 & VT1802P)

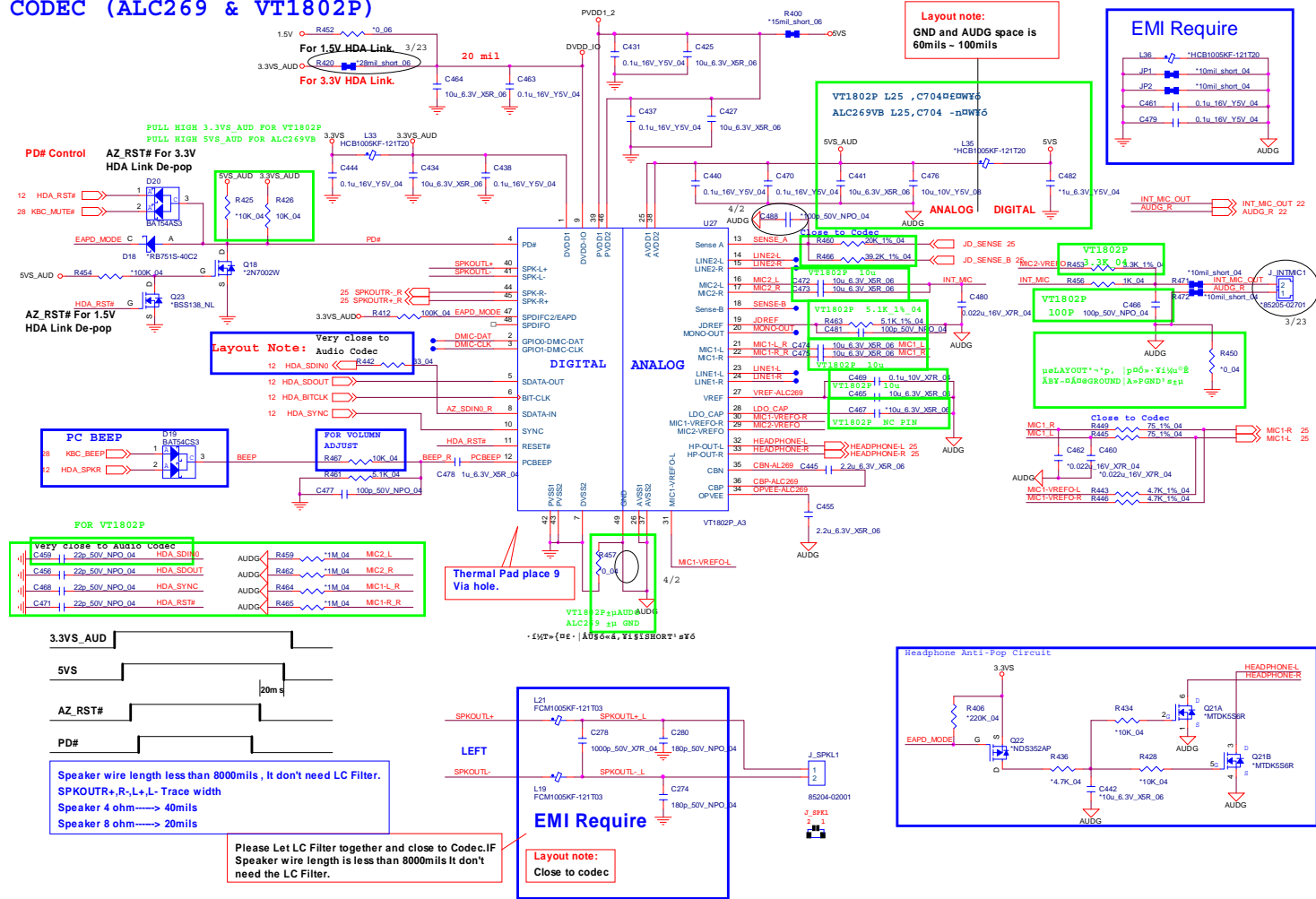

Sheet 27 of 42
AUDIO CODEC
VT1802P

KBC-ITE IT8518E

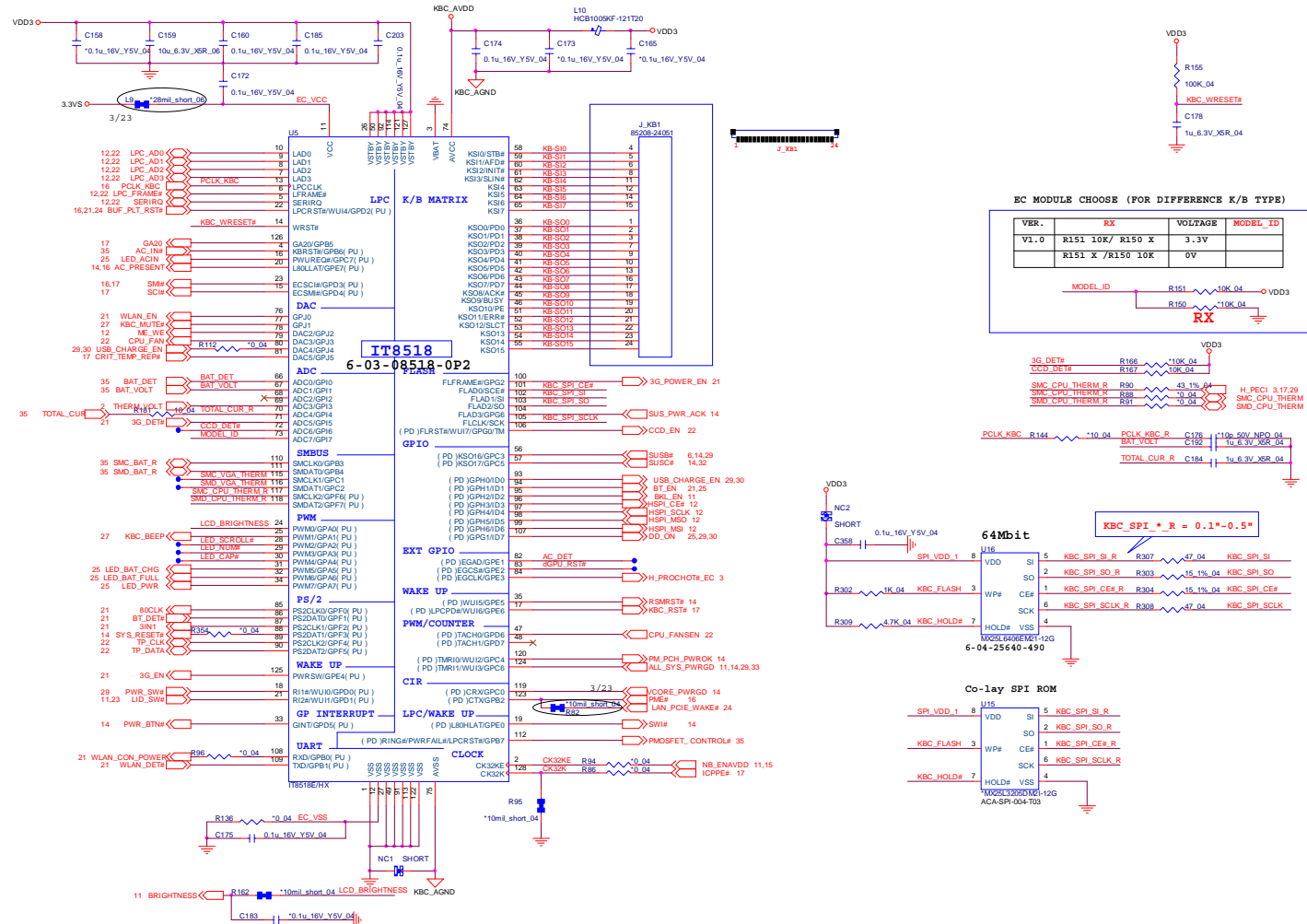

Sheet 28 of 42
KBC-ITE IT8518E

VDD3, VDD5

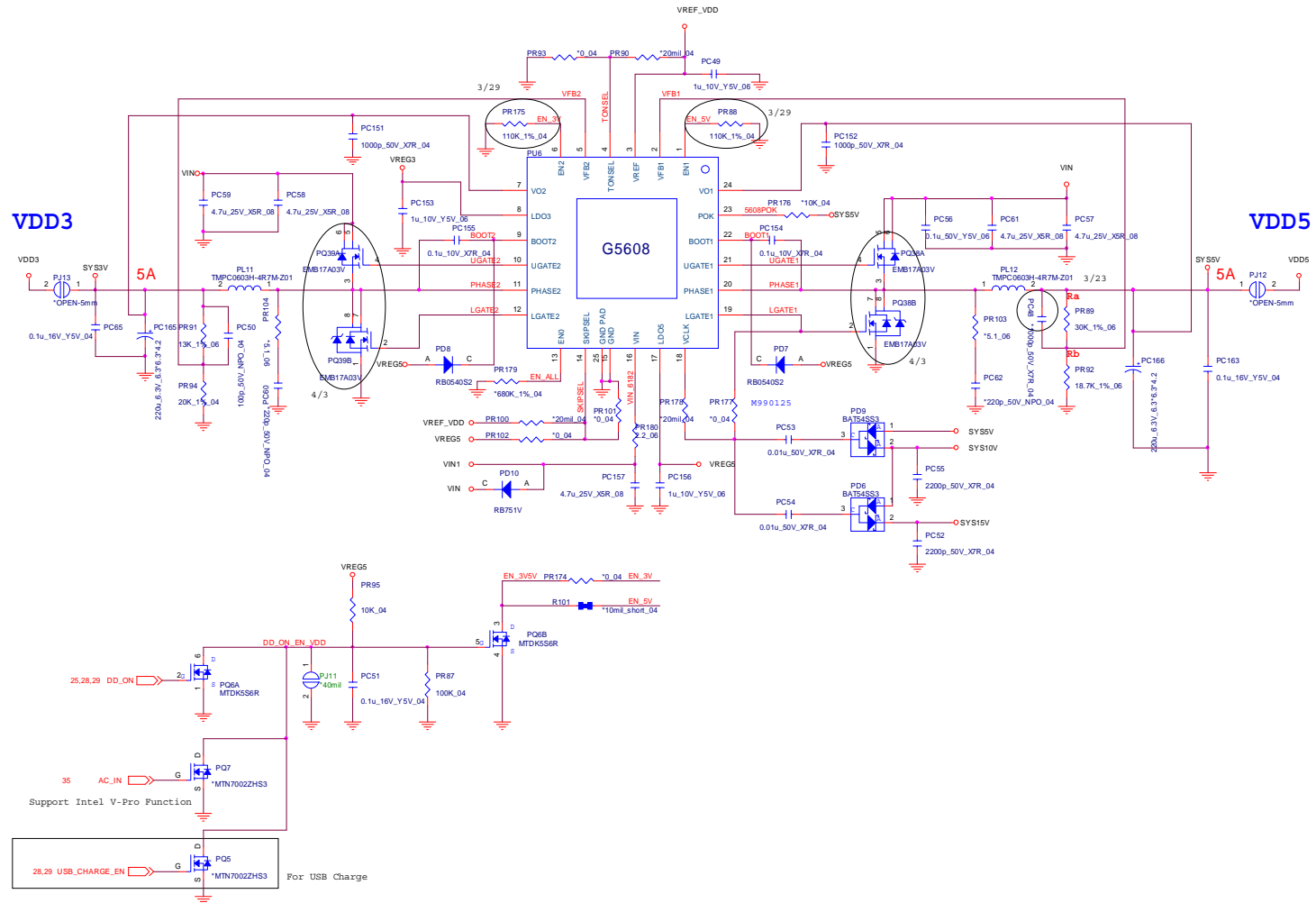

Sheet 30 of 42
VDD3, VDD5

B.Schematic Diagrams

Schematic Diagrams

Power 0.85VS, 1.8VS

B.Schematic Diagrams

Sheet 31 of 42
Power 0.85VS,
1.8VS

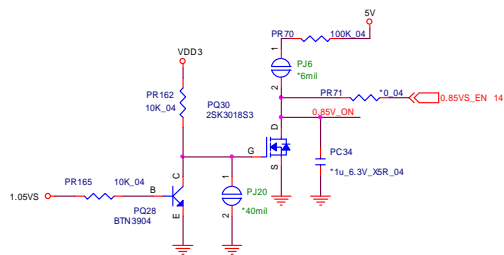
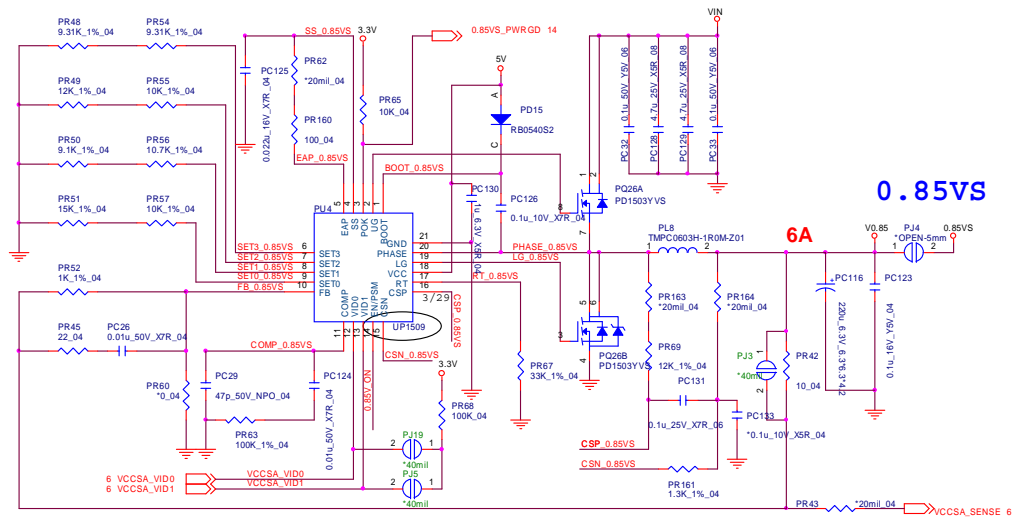
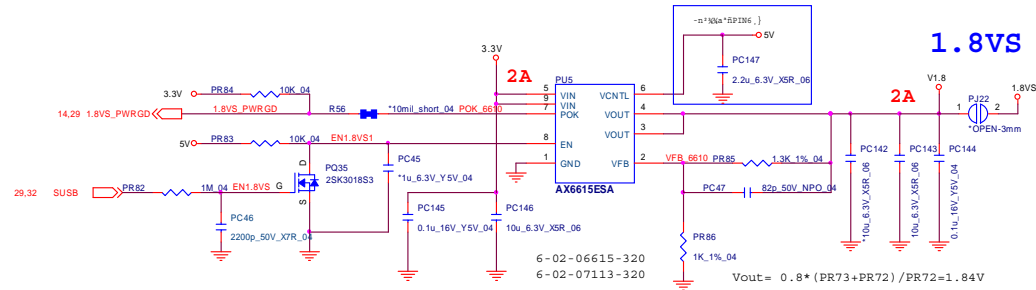

	0.9V	0.8V	0.725V	0.675V
VCCSA_VID0	0	0	1	1
VCCSA_VID1	0	1	0	1

SET0 SET2 SET1 SET3

POWER 1.5V/1.05VS

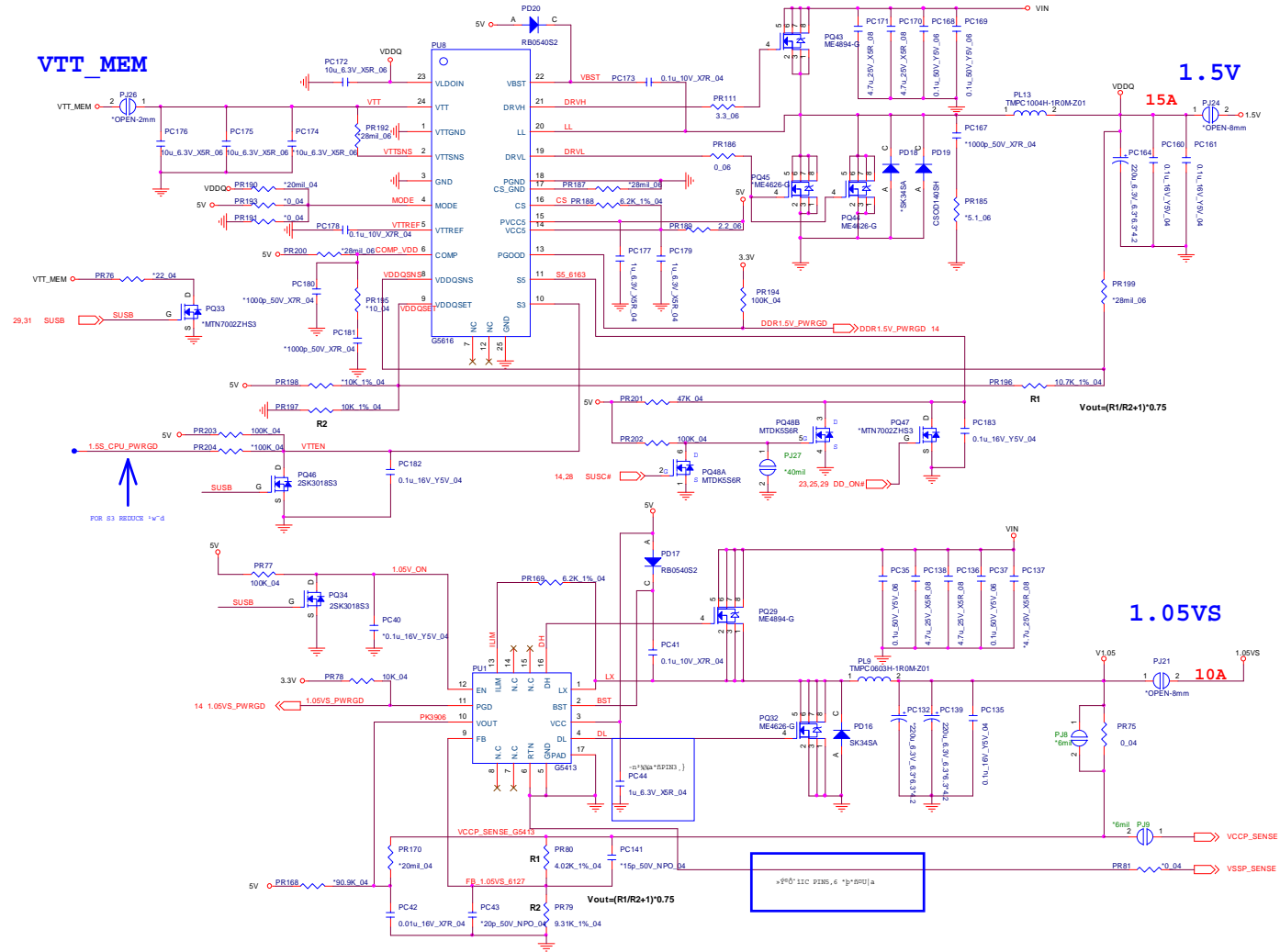

Sheet 32 of 42
POWER 1.5V/
1.05VS

B.Schematic Diagrams

POWER VCORE2

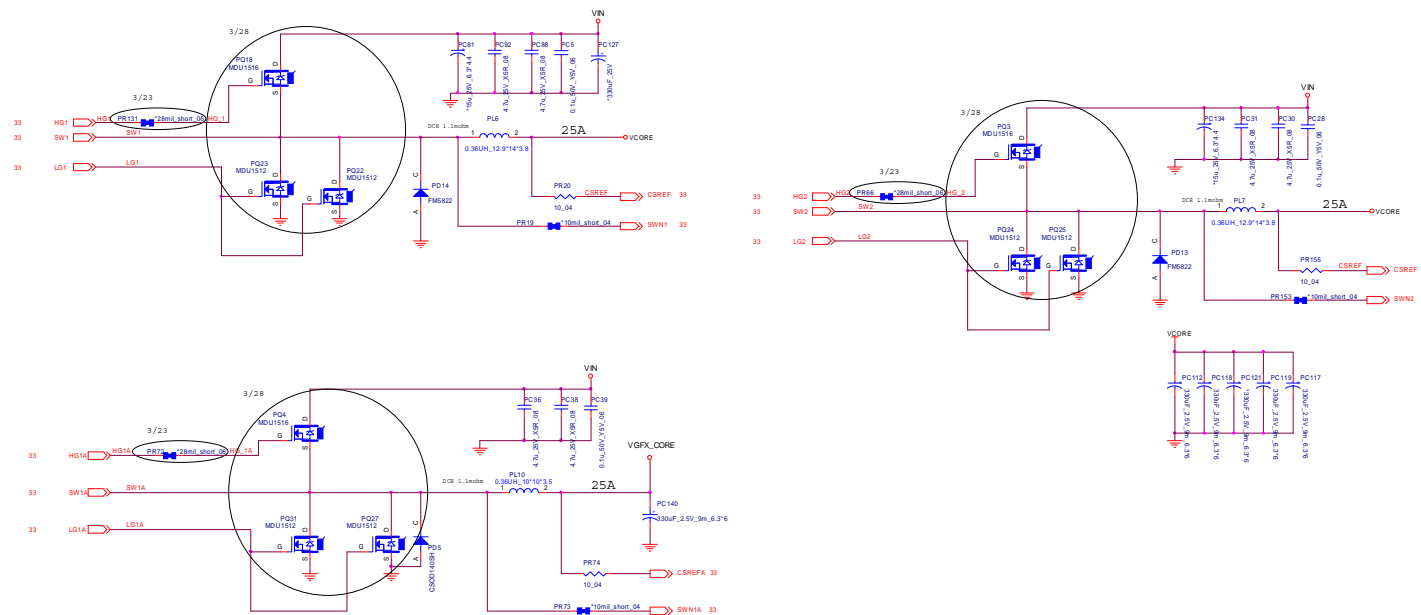

Sheet 34 of 42
POWER VCORE2

B.Schematic Diagrams

AUDIO BOARD

USB PORT

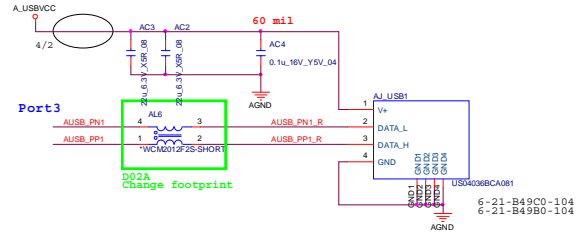

TO M/B

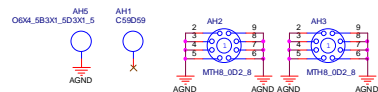
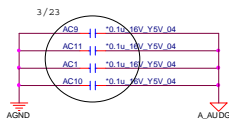
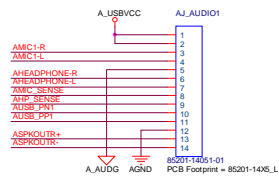

AUDIO JACK

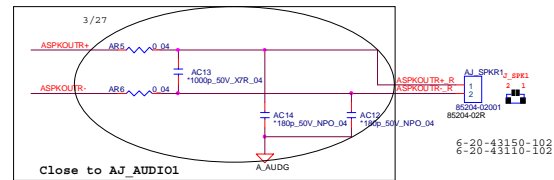
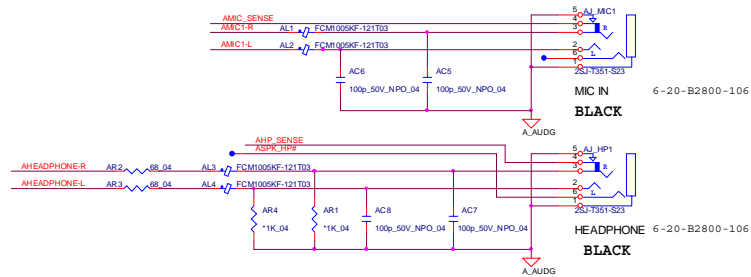

Sheet 36 of 42
AUDIO BOARD

LID SW BOARD (W550EU)

LID SWITCH BOARD

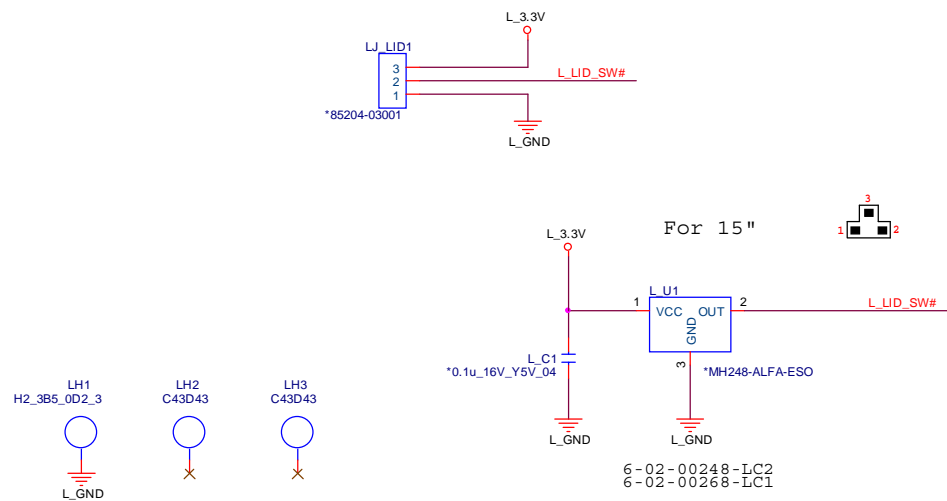

Sheet 38 of 42
LID SW BOARD
(W550EU)

POWER SW BOARD

POWER SW & LED

Sheet 39 of 42
POWER SW
BOARD

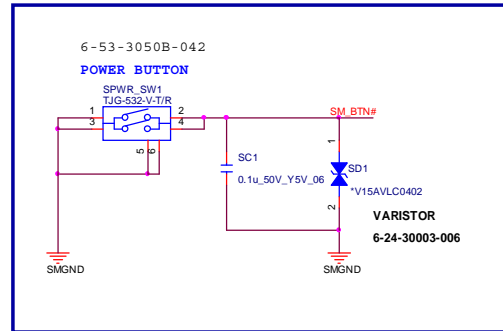
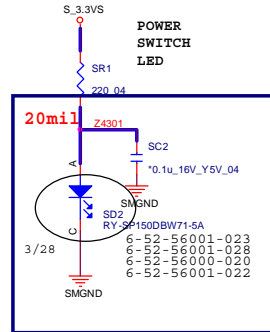
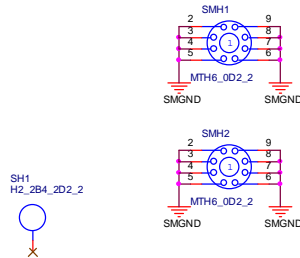
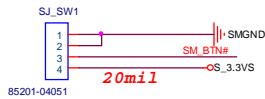

EXTERNAL ODD BOARD

ODD BOARD

FROM M/B

TO ODD

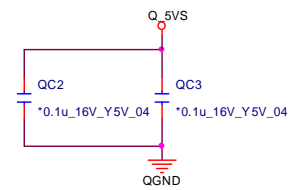
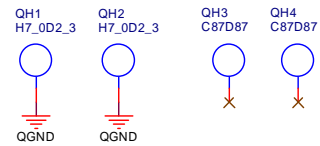
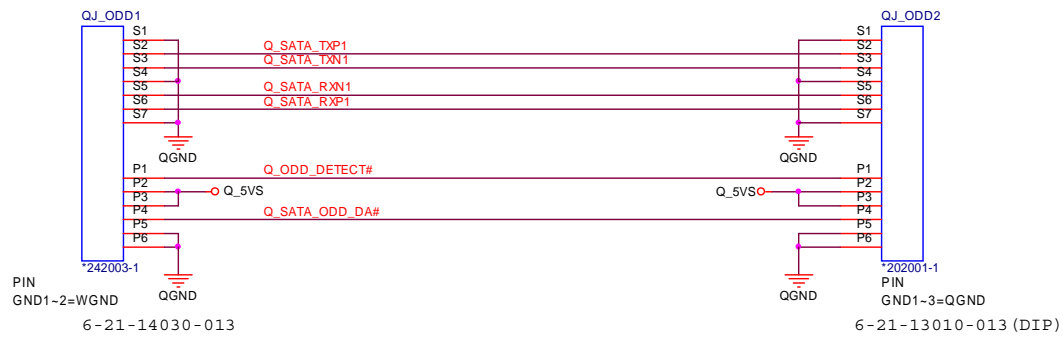

Sheet 40 of 42
EXTERNAL ODD BOARD

Power On SEQ

POWER ON SEQUENCE

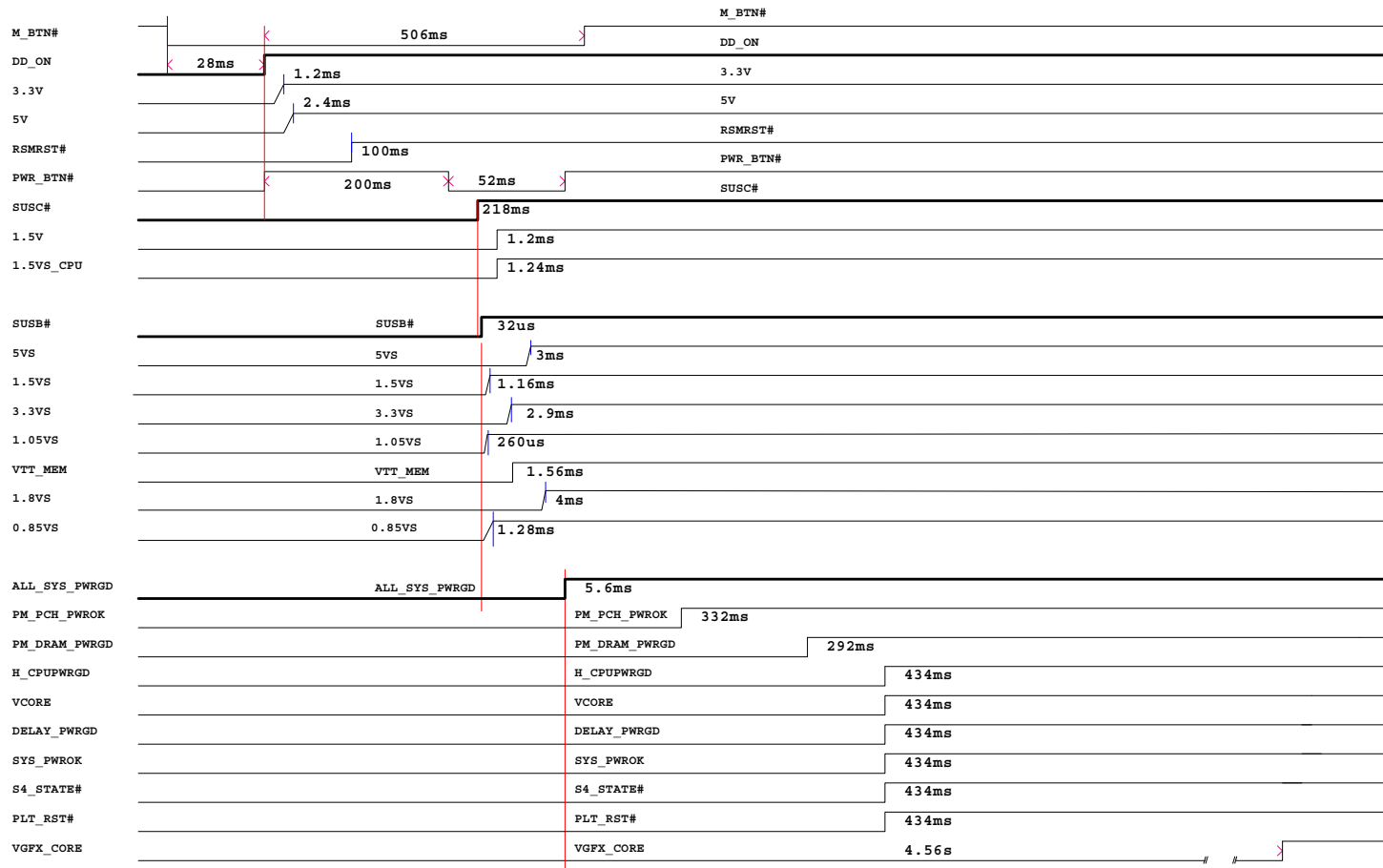

Sheet 42 of 42
Power On SEQ

Schematic Diagrams

Appendix C: Updating the FLASH ROM BIOS

To update the FLASH ROM BIOS, you must:

- Download the BIOS update from the web site.
- Unzip the files onto a bootable CD/DVD/USB Flash Drive.
- Reboot your computer from an external CD/DVD/USB Flash Drive.
- Use the flash tools to update the flash BIOS using the commands indicated below.
- Restart the computer booting from the HDD and press **F2** at startup enter the BIOS.
- Load setup defaults from the BIOS and save the default settings and exit the BIOS to restart the computer.
- After rebooting the computer you may restart the computer again and make any required changes to the default BIOS settings.

Download the BIOS

1. Go to www.clevo.com.tw and point to **E-Services** and click **E-Channel**.
2. Use your user ID and password to access the appropriate download area (BIOS), and download the latest BIOS files (the BIOS file will be contained in a batch file that may be run directly once unzipped) for your computer model (see sidebar for important information on BIOS versions).

Unzip the downloaded files to a bootable CD/DVD/ or USB Flash drive

1. Insert a bootable CD/DVD/USB flash drive into the CD/DVD drive/USB port of the computer containing the downloaded files.
2. Use a tool such as Winzip or Winrar to unzip all the BIOS files and refresh tools to your bootable CD/DVD/USB flash drive (you may need to create a bootable CD/DVD with the files using a 3rd party software).

Set the computer to boot from the external drive

1. With the bootable CD/DVD/USB flash drive containing the BIOS files in your CD/DVD drive/USB port, restart the computer and press **F2** (in most cases) to enter the BIOS.
2. Use the arrow keys to highlight the **Boot** menu.
3. Use the “+” and “-” keys to move boot devices up and down the priority order.
4. Make sure that the CD/DVD drive/USB flash drive is set first in the boot priority of the BIOS.
5. Press **F10** to save any changes you have made and exit the BIOS to restart the computer.



BIOS Version

Make sure you download the latest correct version of the BIOS appropriate for the computer model you are working on.

You should only download BIOS versions that are **V1.01.XX or higher** as appropriate for your computer model.

Note that BIOS versions are not backward compatible and therefore **you may not downgrade your BIOS to an older version** after upgrading to a later version (e.g if you upgrade a BIOS to ver 1.01.05, you **MAY NOT** then go back and flash the BIOS to ver 1.01.04).

BIOS Update

Use the flash tools to update the BIOS

1. Make sure you are not loading any memory management programs such as HIMEM by holding the **F8** key as you see the message “**Starting MS-DOS**”. You will then be prompted to give “**Y**” or “**N**” responses to the programs being loaded by DOS. Choose “**N**” for any memory management programs.
2. You should now be at the DOS prompt e.g: DISK C:\> (C is the designated drive letter for the CD/DVD drive/USB flash drive).
3. **Type the following command** at the DOS prompt:

C:\> Flash.bat

4. The utility will then proceed to flash the BIOS.
5. You should then be prompted to press any key to restart the system or turn the power off, and then on again but make sure you remove the CD/DVD/USB flash drive from the CD/DVD drive/USB port before the computer restarts.

Restart the computer (booting from the HDD)

1. With the CD/DVD/USB flash drive removed from the CD/DVD drive/USB port the computer should restart from the HDD.
2. Press **F2** as the computer restarts to enter the BIOS.
3. Use the arrow keys to highlight the **Exit** menu.
4. Select **Load Setup Defaults** (or press **F9**) and select “**Yes**” to confirm the selection.
5. Press **F10** to save any changes you have made and exit the BIOS to restart the computer.

Your computer is now running normally with the updated BIOS

You may now enter the BIOS and make any changes you require to the default settings.